

Solutions for  
**Pharmaceutical Analysis**

Application Notebook



## Basic Research and Drug Discovery

### **Development of a Phospholipid Profiling Method Using Triple Quadrupole LC-MS/MS**

This article shows the LC-MS/MS MRM library (phospholipids) can be used for easy phospholipid profiling and fatty acid composition determination.

### **Phospholipid Analysis Using SimLipid Software**

We show the analyzing results by LCMS-8060 of phospholipid changes in a liver tissue between a control and a mouse which a fluorescent probe has been administered by a tail vein injection. In this analysis, SimLipid software from PREMIER Biosoft, USA was used to estimate the candidate of PLs fluctuated between a control and a probe administered mouse.

### **Phospholipid Analysis for Four Types of Mouse Tissues**

Phospholipids characteristic of each tissue were detected from four different tissue extracts and the effectiveness of the database search by SimLipid software was confirmed.

### **LC/MS/MS MRM Library for Phospholipid Profiling [Flyer]**

### **A Study of Toxicity Evaluation Using the iMScope *TRIO* - Analysis of Localization of Amiodarone in Rat Lungs -**

We introduce an example of MS imaging analysis using the iMScope *TRIO* imaging mass microscope to compare the localization of the pathological findings with that of the amiodarone observed in lung tissue after administering amiodarone to rats.

### **Simultaneous Analysis of Tyrosine Kinase Inhibitors in Human Blood Plasma with LC-MS/MS**

This article introduces an example of simultaneous analysis of EGFR-TKIs, ALK-TKIs, and metabolites in human blood plasma for the purpose of research into pharmacokinetics using the triple quadrupole high performance liquid chromatograph mass spectrometer LCMS-8050.

## LC Method Development

### **Ultra-High Speed Analysis of USP Methods Conforming to Permissible Limits in New USP General Chapter 621**

We introduce an example of a faster analysis of a USP method in compliance with the new General Chapter 621 using the Nexera X2 ultra high performance liquid chromatograph and the Shim-pack XR-ODS III high-speed analytical column.

### **Analysis of Omeprazole by "i-Series" for USP and JP Methods**

This Application News introduces an example of analysis of omeprazole in accordance with JP and USP. Also presented here is an example of analysis that can be completed in a significantly shorter time than that described in the USP General Chapter 621 Chromatography.

### **High Speed Analysis of Pharmaceutical Impurities in Compliance with European Pharmacopoeia Using Nexera-i MT**

This article introduces an example of high speed analysis of pharmaceuticals and related substances in compliance with the EP using the Nexera-i MT integrated high performance liquid chromatograph.

### **Analysis of Montelukast Sodium Using Prominence-i and Nexera-i MT**

This article introduces system suitability tests of montelukast sodium using Prominence-i and Nexera-i MT in compliance with the 17<sup>th</sup> edition of JP.

### **Isolation and Identification of Atorvastatin Degradation Impurities by UFPLC**

Prominence UFPLC, Ultra Fast Preparative and Purification Liquid Chromatograph enables fast recovery of highly purified target compounds from complex samples such as organic synthesis reaction mixtures and natural products. This article describes an example of Atorvastatin and its impurities.

## Chiral Separation

### **Automated Optimization of Chiral Separation Parameters Using Nexera UC Chiral Screening System**

This article describes using the Nexera UC chiral screening system to automatically optimize the large number of separation parameters by switching between up to 12 columns and various mixture ratios of four types of modifiers. This can significantly reduce the effort required.

### **Analysis and Evaluation of Chiral Drugs in Biological Samples Using the Nexera UC-MS/MS System**

This article introduces an example of the selectivity and sensitivity of drug level monitoring in a biological sample and the evaluation results of the analysis method, as an application to the pharmacokinetics research of chiral separation using SFC-MS/MS, after having selected an appropriate column.

### **Analysis of Choline and Acetylcholine in Rat Cerebrospinal Fluid Samples Using the Nexera UC-MS/MS System**

This article focuses on the SFC analysis of these compounds in a rat cerebrospinal fluid sample by direct injection of the cerebrospinal fluid to the Nexera UC SFC system. Also introduced is automatic extraction and analysis of a cerebrospinal fluid sample impregnated into filter paper, in consideration of convenience and durability for storage and transport, using the Nexera UC online SFE-SFC-MS/MS system.

### **Developing a Chiral Amino Acid Analysis Method That Uses Column Switching**

This article introduces a rapid analysis method that employs chiral columns to achieve high separation and high sensitivity and that dispenses with derivatization.

### **Upgrade Your Existing UHPLC to an UHPLC/SFC Switching System [Flyer]**

## Polymorphism Analysis

### **Polymorphism of Drugs**

An example use of DSC to analyze polymorphs was described.

## Cleaning Validation

### **Application of Online SFE-SFC-PDA for Cleaning Validation**

This article describes the process of column selection using the Nexera-UC Chiral Screening System as the first step in analysis of the target compound alkylbenzenesulfonate.

### **LabSolutions LCMS Measurement Result Judgment Assistance Software -iFlagger- [Flyer]**

### **Optional Software for LabSolutions DB LCMS and LabSolutions CS -LabSolutions Report Plus™ Software- [Flyer]**

## Excipient Analysis

### **System Suitability Testing for Hydroxypropyl Cellulose**

This article introduces examination results of system suitability for quantitative testing of hydroxypropyl cellulose in conformance with the USP.

### **Analysis of Mannitol Using RID-20A Differential Index Detector**

USP methods for D-mannitol were amended in 2014 to specify the use of refractive index detection with a 7.8 mm × 300 mm L19 column. We introduce an example of mannitol analysis using the RID-20A.

## Residual Solvent Analysis

### **Analysis of Residual Solvents in Drug Products Using Nexis GC-2030 Combined with HS-20 Headspace Sampler - USP <467> Residual Solvents Procedure A -**

This Application News presents data obtained using the Shimadzu HS-20 Headspace Sampler and Nexis GC-2030 Gas Chromatograph, from Class 1 and Class 2 standard solutions, in accordance with Water-soluble Articles, Procedure A, in USP <467> Residual Solvents.

### **Analysis of Residual Solvents in Pharmaceuticals Using Headspace GC-FID/MS Detector Splitting System**

We describe an example of residual solvent test of a pharmaceutical using a detector splitting system that simultaneously obtains FID and MS data in a single measurement.

### **Gas Chromatograph Nexis GC-2030 [Flyer]**

### **Using GCMS to Test for Residual Solvents in Pharmaceuticals [Flyer]**

### **GCMS Solutions for Pharmaceuticals [Flyer]**

### **Analysis of Styrene Leached from Polystyrene Cups Using GCMS Coupled with Headspace Sampler**

The objective of this study is to develop a sensitive, selective, accurate and reliable method for styrene determination using low carryover headspace sampler, HS-20 coupled with Ultra Fast Scan Speed 20,000 u/sec, GCMS-QP2010 Ultra to assess the risk involved in using polystyrene cups.

## Elemental Impurity Analysis

### **Analysis by ICP Atomic Emission Spectrometry in Accordance with the ICH Q3D Guideline for Elemental Impurities Using ICPE-9820**

Use of the ICPE-9820 permits quick, accurate analysis of the 24 elements specified in the ICH Q3D guideline.

# Application News

## No. C137

### Liquid Chromatography Mass Spectrometry

## Development of a Phospholipid Profiling Method Using Triple Quadrupole LC/MS/MS

The lipid bilayer membrane structure of cell membranes is formed of phospholipids, with fatty acid chains oriented inside the membrane and polar groups situated on the membrane surface. Precursors of physiologically active lipids bound to phospholipids as fatty acids include polyunsaturated fatty acids such as arachidonic acid, EPA, and DHA. These lipids contribute to the formation of a wide variety of membrane structures. Due to recent reports of a causal association between phospholipid compositions and various diseases, phospholipid profiling techniques have gained interest as an important approach in disease marker screening and disease mechanism identification.

Shimadzu has created a phospholipid profiling LC/MS/MS MRM library for the classification of phospholipids in biological samples. Phospholipids are divided into glycerophospholipids and sphingophospholipids. Qualitative analysis of phospholipids by MS/MS involves phospholipid classification via the detection of product ions created by polar group elimination, such as choline and ethanolamine elimination, and subsequent

phospholipid structure prediction based on molecular ions (Fig. 1). The Shimadzu MRM library includes 422 constituents (1<sup>st</sup> method), and the phospholipid targets of the library are phosphatidylcholines (PC), phosphatidylethanolamines (PE), phosphatidylserines (PS), phosphatidylglycerol (PG), phosphatidylinositol (PI), and sphingomyelins (SM). A list of the fatty acids included as analytical targets are shown in the table on the right in Fig. 1. A single chromatographic analysis can be used to profile 422 phospholipid constituents. The MRM library also includes 867 MRM transitions that are needed to determine the fatty acid composition. The phospholipid profiling workflow begins with the 1<sup>st</sup> method, after which the 2<sup>nd</sup> method is performed if the fatty acid composition analysis is needed. Shimadzu has also created the MRM Event Link Editor that edits MRM methods, and is needed to create a 2<sup>nd</sup> method from the 867 MRM library transitions.

The library allows for easy phospholipid profiling with a triple quadrupole mass spectrometer, and stress-free fatty acid composition analysis.

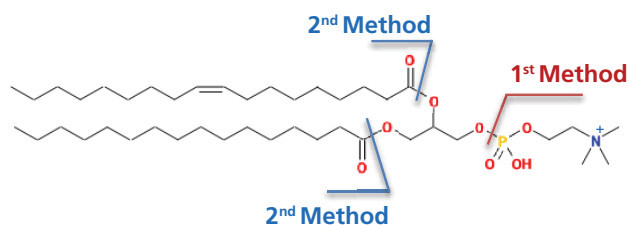

		Number of Double Bonds					
Carbon Number	C14:0	C14:1					
	C16:0	C16:1					
	C18:0	C18:1	C18:2	C18:3			
	C20:0	C20:1	C20:2	C20:3	C20:4	C20:5	
	C22:0	C22:1	C22:6				

**Fig. 1** PS (16:0/18:1) structure and fragmentation points (left), and tabulated list of fatty acids (right). Here, the 1<sup>st</sup> method refers to MRM that analyzes product ions obtained by polar head group elimination, and the 2<sup>nd</sup> method refers to MRM that analyzes fatty acid product ions.



**Fig. 2** Workflow of MRM based phospholipid profiling. Structural information obtained from the 1<sup>st</sup> method comprises the polar head group, and the total carbon number of the fatty acids and number of double bonds (eg: PC (34:1)). The 2<sup>nd</sup> method is used to determine the fatty acid composition of the constituent obtained in the 1<sup>st</sup> method, such as PC (16:0/18:1) from PC (34:1).

#### HPLC Conditions

Analytical Column	: Phenomenex Kinetex C8 (150 mm L × 2.1 mm I.D., 2.6 μm)
Mobile Phase A	: 20 mM ammonium formate
Mobile Phase B	: Acetonitrile/Isopropanol (1:1)
Time Program (B %)	: 20 % (0 min) → 20 % (1 min) → 40 % (2 min) → 92.5 % (25 min) → 100 % (26 min) → 100 % (35 min)
Flowrate	: 0.3 mL/min
Injection Volume	: 3 μL
Column Oven Temperature	: 45 °C

#### MS Conditions (LCMS-8050)

Ionization Method	: ESI (Positive/Negative)
Nebulizer Gas Flowrate	: 3.0 L/min
Drying Gas Flowrate	: 10.0 L/min
Heating Gas	: 10.0 L/min
DL Temperature	: 250 °C
Heater Block Temperature	: 400 °C
Interface Temperature	: 300 °C
CID Gas Pressure	: 230 kPa

The LCMS-8050 system was used with a phospholipid MRM library 1<sup>st</sup> method (MRM of 422 phospholipid constituents) to profile a lipid extract obtained from mouse brain. As a result, the peaks were detected for 130 constituents, and the peak heights of 102 constituents were 10,000 or above.

MRM Event Link Editor was used to create a 2<sup>nd</sup> method, which is needed to determine the fatty acid composition of the peaks detected by the 1<sup>st</sup> method, and analysis was performed. Taking PC (38:4) as an example, the MRM Event Link Editor software creates a method from the MRM transitions expected for all possible combinations of fatty acids (18:0/20:4, 18:1/20:3, 18:2/20:2, 18:3/20:1) in ESI negative mode (ESI (-)), and takes those transitions from the 867 MRM transitions in the MRM library. The 2<sup>nd</sup> method would also include the MRM transitions used in the 1<sup>st</sup> method to monitor for eliminated polar head groups.

For the 33 possible fatty acid compositions, the peak areas obtained from MRM monitoring of polar head groups are shown in the vertical axis in Fig. 3. For PC (38:4), the MRM chromatogram obtained from the 2<sup>nd</sup> method is shown on the bottom left of Fig. 3. The MRM chromatogram obtained when monitoring for the polar head group (choline), which is shown above the 2<sup>nd</sup> method chromatogram, detected a main peak at 15.5 minutes. The MRM chromatogram below is for fatty acid product ions with compositions of 18:0 (stearic acid) and 20:4 (arachidonic acid). The MRM chromatograms obtained for other fatty acid combinations did not detect a peak at 15.5 minutes, showing that the main fatty acid combination is 18:0/20:4.

This article shows the LC/MS/MS MRM library (phospholipids) can be used for easy phospholipid profiling and fatty acid composition determination.

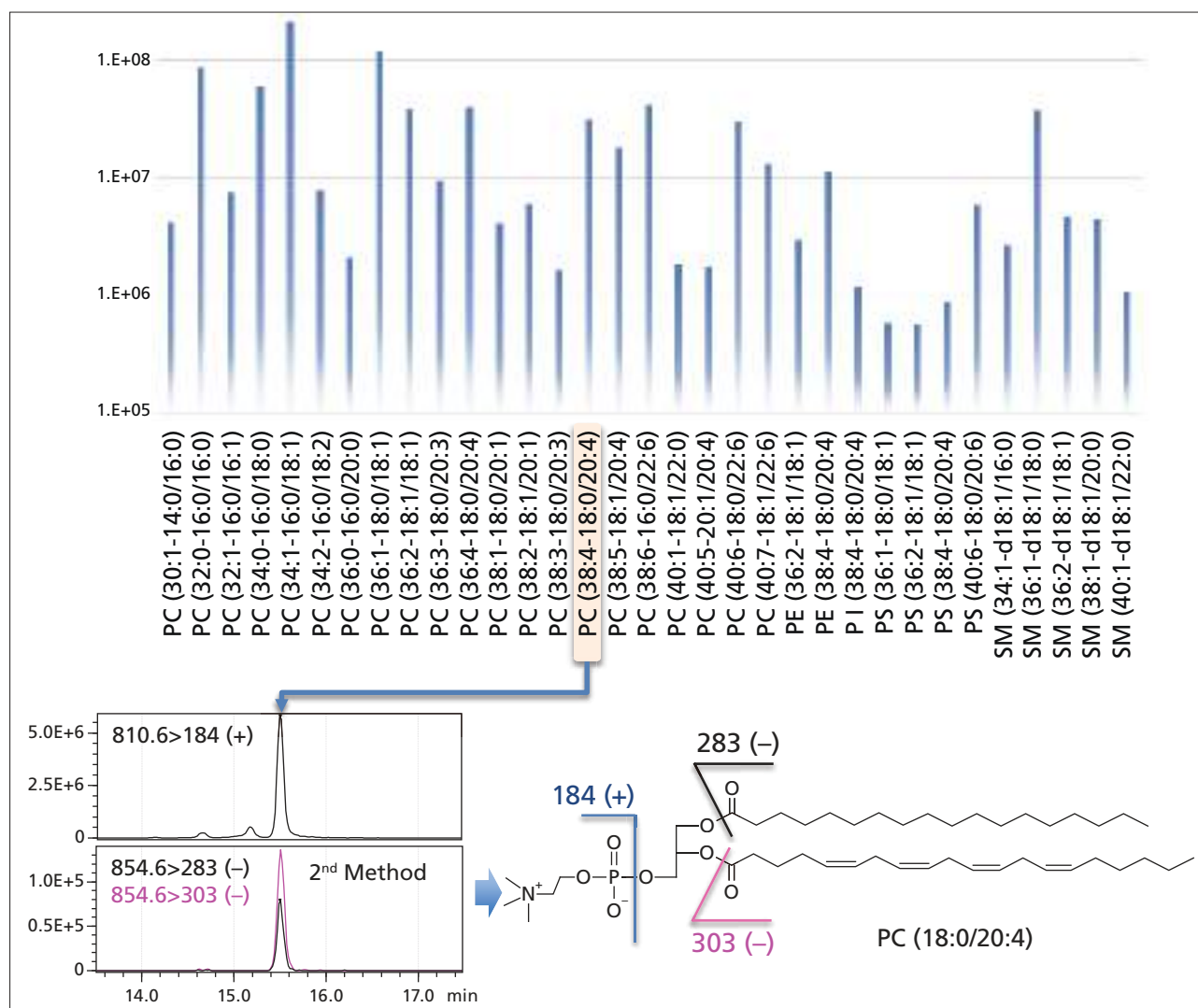

Fig. 3 Profiling results for PC in mouse brain lipid extract (top image). The MRM chromatogram used to determine the fatty acid composition of PC (38:4) (bottom left) showed the fatty acid composition was 18:0/20:4 (bottom right).

First Edition: Oct. 2016



For Research Use Only. Not for use in diagnostic procedure.

This publication may contain references to products that are not available in your country. Please contact us to check the availability of these products in your country.

The content of this publication shall not be reproduced, altered or sold for any commercial purpose without the written approval of Shimadzu. Company names, product/service names and logos used in this publication are trademarks and trade names of Shimadzu Corporation or its affiliates, whether or not they are used with trademark symbol "TM" or "®". Third-party trademarks and trade names may be used in this publication to refer to either the entities or their products/services. Shimadzu disclaims any proprietary interest in trademarks and trade names other than its own.

The information contained herein is provided to you "as is" without warranty of any kind including without limitation warranties as to its accuracy or completeness. Shimadzu does not assume any responsibility or liability for any damage, whether direct or indirect, relating to the use of this publication. This publication is based upon the information available to Shimadzu on or before the date of publication, and subject to change without notice.

Shimadzu Corporation  
www.shimadzu.com/an/

# Application News

## No. C151

LC/MS

### Phospholipid analysis using SimLipid software

Phospholipids (PLs) have a role of constituting a cellular membrane in a living cell and are also related to produce various fatty acids such as arachidonic acids, EPA and DHA which are precursors of bioactive lipids. Fluctuation of PLs concentration in a blood or a tissue is also known to be correlated with various disease. For example, Hyperlipidemia and arteriosclerosis are known to induce an elevation of lipid concentration in a blood and some nervous diseases are reported to change the ratio of fatty acid constitution of phospholipids. Thus although phospholipids are reported to be related with various disease, a number of phospholipid species is enormous. PLs are classified to glycerophospholipid and sphingophospholipid by the structural body. Furthermore, PLs are classified to PC, PE, PG, PI, PS, PA and SM by its characteristic head group. These PLs have diverse fatty acids different in a length of carbon chain, an number of double-bond.

Here we shows the analyzing results by LCMS-8060 of phospholipid changes in a liver tissue between a control and a mouse which a fluorescent probe has been administered by a tail vein injection. In this analysis, SimLipid software from PREMIER Biosoft, USA ([www.premierbiosoft.com](http://www.premierbiosoft.com)) was used to estimate the candidate of PLs fluctuated between a control and a probe administered mouse.

T. Nakanishi

**Table 1 HPLC condition**

Column	: Phenomenex Kinetex C8 (150 × 2.1 mm, 2.6 μm)
Mobile phase A	: 20 mmol/L Ammonium formate
Mobile phase B	: Acetonitrile/2-propanol (1:1)
Flow rate of mobile phase	: 0.3 mL/min
Time program (B%)	: 20 % (0 min) → 20 % (1 min) → 40 % (2 min) → 92.5 % (25 min) → 100 % (26 – 30 min) Curved gradient from 2 min to 25 min.
Column temp.	: 45 °C
Injection volume	: 3 μL

**Table 2 MS Condition (LCMS-8060)**

Ionization	: ESI (+) / (-)
Nebulizer gas flow rate	: 3 L/min
Heating gas flow rate	: 10 L/min
Drying gas flow rate	: 10 L/min
Probe voltage	: 4 kV (+) / -3 kV (-)
Interface temperature	: 300 °C
DL temperature	: 250 °C
Block heater temperature.	: 400 °C

#### Sample preparation and analysis

Carbon nano tube (CNT) probe is known as a fluorescent probe for a long-wavelength to visualize an administered target molecule inside a living body. This probe was administered to a mouse at a concentration of 300 μg/mL by a tail vein injection (100 μL). After 5hr of administering, liver tissues were isolated from a control mouse and a administered mouse. The isolated tissues were rapidly frozen in liquid nitrogen and crushed to some blocks of an appropriate size. Then these tissue blocks were weighed. Furthermore, after crushing frozen tissue blocks by a bead type crusher, phospholipids were extracted by Bligh & Dyer method. Organic phase was recovered and then evaporated. The sample was dissolved with a solution of CHCl<sub>3</sub>/MeOH (1:1). Phospholipid profiling by precursor ion scan (PIS) and neutral loss scan (NLS) with LCMS-8060 were executed for the sample diluted with MeOH (Table 1). In this case, phospholipid analysis were carried out by PIS at *m/z* 184 focusing on the characteristic head groups of PC and SM or NLS of 141 for ethanolamine of PE (Figure 1). The candidate of phospholipids was estimated for each peak detected on PIS and NLS analysis as a result of database search by SimLipid software (Figure 2).

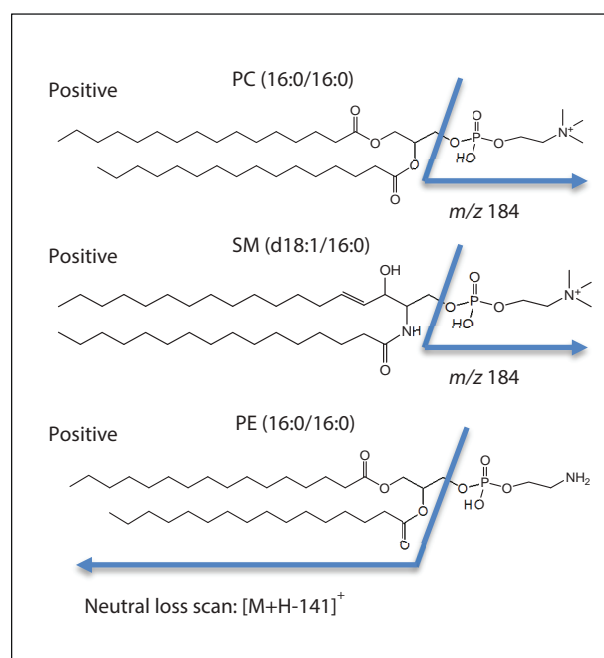

**Fig. 1 Structural formula of PC, SM and PE**



# Application News

## No. C155

LC/MS

### Phospholipid analysis for four types of mouse tissues

Phospholipids, a complex lipid, play a major role in formation of lipid bilayer as a major component of the cell membrane together with glycolipids and cholesterol *in vivo*. In addition to constituting cell membranes, it also function as a source of fatty acids involved in energy production by lipid metabolism, lipid transport and signal transduction. Thus, although a phospholipid works for various function *in vivo*, its number is enormous because of the combination of a characteristic head group and fatty acid constituting its structure. Therefore, in the field of lipidomics, qualitative analysis utilizing an enormous database is often performed based on information such as *m/z* of phospholipids, the product ion derived from the characteristic head group and from each fatty acid. Here phospholipid analysis was performed by precursor ion scan (PIS) or neutral loss scan (NLS) with a triple quadrupole mass spectrometer for mice – derived brain, spleen, lung and liver tissues. In estimating candidate phospholipids, we performed the database search using SimLipid software from PREMIER Biosoft, USA ([www.premierbiosoft.com](http://www.premierbiosoft.com)). Phospholipids characteristic of each tissue were detected from four different tissue extracts and the effectiveness of the database search by SimLipid software was confirmed.

#### ■ Sample preparation and analysis

Lipid extraction from each tissue was performed using methanol. The prepared tissue extract was diluted appropriately with methanol and then phospholipids were analyzed by precursor ion scan (PIS) and neutral loss scan (NLS) with LCMS-8060. In this analysis, PIS/NLS for the characteristic head group and PIS for representative fatty acids, FA(16:0), FA(18:0), FA(18:1), FA(20:4), FA(20:5), FA(22:4), FA(22:5) and FA(22:6), were performed. The LC and MS analysis in this experiment, are analyzed under the same analysis condition as Application News C151. Figure 1 a) shows the analysis results of PIS focusing of some fatty acids of PLs. From the results in Fig. 1 b), peaks of PLs corresponding to PC and SM were detected and some peaks assumed to be derived from other phospholipids and neutral lipids were also found.

M. Yamada, T. Nakanishi

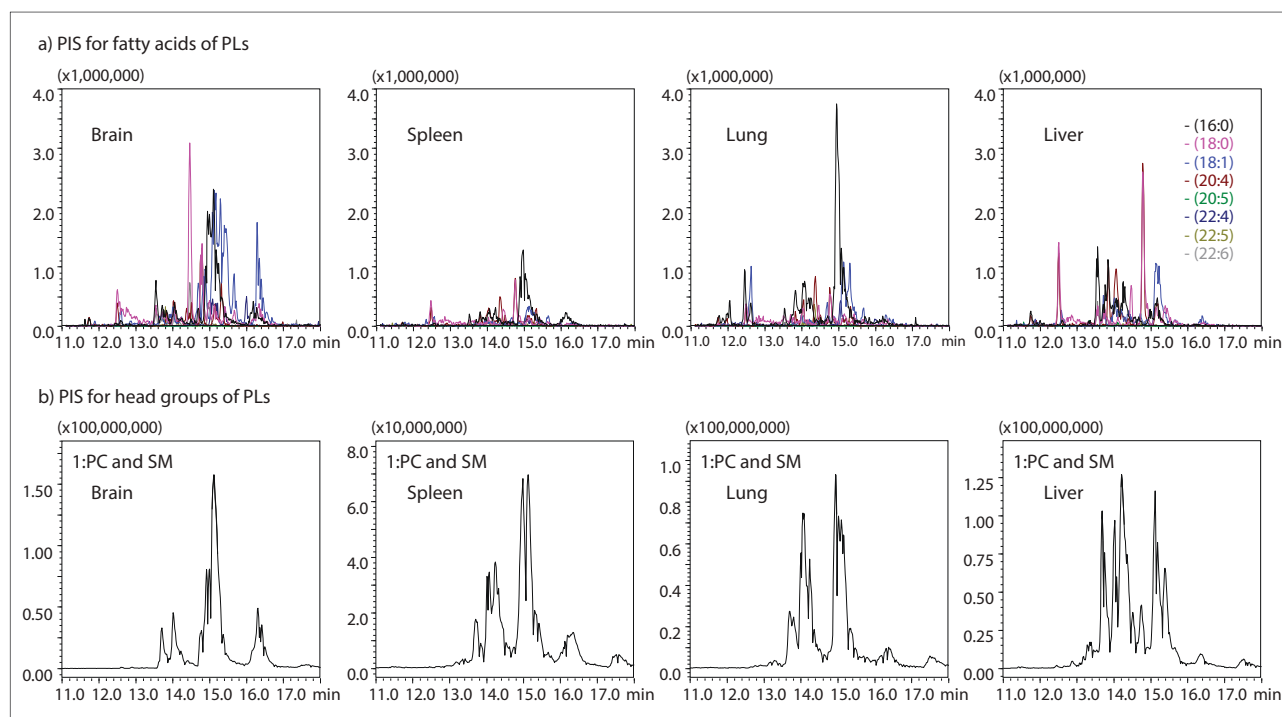

Fig. 1 Chromatogram of PIS analysis for fatty acids and head group (brain, spleen, lung and liver)



### Estimate of phospholipids by SimLipid

Based on the PIS and NLS analysis results shown in Figure 1, we conducted a database search using SimLipid software to estimate the phospholipids of each detected peak. First the data acquired by LCMS-8060 was read directly by SimLipid software and then the peak intensity detected by PIS and NLS analysis were calculated for each sample. We conducted a database search on the basis of a tolerance, presence/absence of adduct ion and selection of product ion (fatty acids or head groups) for the set mass value. In SimLipid software, thousands of phospholipids are registered in the database and the peaks detected under the preset conditions are compared with the database. Figure 2 shows an example of database search of lung tissue analysis results. Here information about each phospholipid class and the total number of carbon chain and double bonds of fatty acids for the corresponding peak, are estimated as a result of database search. The integrated intensity of the corresponding peak "Total Abundance" is displayed in Figure 2 (n=4).

### Phospholipids in four tissue samples

Figure 3 shows the peak intensities "Total Abundance" of phospholipids confirmed in all tissue samples among the PLs estimated in each tissue as a result of the database search. From Figure 3, we can see the phospholipids characteristic to each tissue. For example, PC(32:0) is known as the main component of pulmonary surfactant which has the function of decreasing the surface tension of the alveoli, and PC(32:1) is also contained a lot. It is also known that there are many phosphatidylcholines including palmitic acid (16:0) and oleic acid (18:1) in the cerebral cortex of the brain. Furthermore, we can see that many phospholipids are remarkably contained in the liver tissue in this result.

By the database search using SimLipid software as shown here, it enables to estimate a kind of phospholipid contained in the sample from enormous phospholipids.

Selected	Sheet Name	#C.#DB	Class	IS Name	Amount of IS	#I.#M			
						Occ. Int.	Cor. Int.	Total Abundance	
<input checked="" type="checkbox"/>	PC(32:0)	32.0	PC		51066419.8	1489235.633	21976379.736	No.18	
<input checked="" type="checkbox"/>	PC(32:1)	32.1	PC		70027197.990	213477074.775	399117810.8931	No.18	
<input checked="" type="checkbox"/>	PC(34:1)	34.1	PC		758668829.0	168078748.7318	260249703.0024	No.18	
<input checked="" type="checkbox"/>	PC(34:2)	34.2	PC		508578742.0	727054954.5	794583550.9194	No.18	
<input checked="" type="checkbox"/>	PC(36:2)	36.2	PC		8217419.8	2889447.4147	2147485.7852	No.18	
<input checked="" type="checkbox"/>	PC(36:4)	36.4	PC		323875795.0	8889946.25	126758344.7165	No.18	
<input checked="" type="checkbox"/>	PC(38:4)	38.4	PC		128641884.0	78458865.824	8876388.7388	No.18	
<input checked="" type="checkbox"/>	PC(38:5)	38.5	PC		80312184.8	15879026.0	24133287.3098	No.18	
<input checked="" type="checkbox"/>	PG(30:3)	30.3	PG		464268.8	118015.0	151473.847	No.18	
<input checked="" type="checkbox"/>	PI(17:2)	17.2	PI		1177587.8	28396.78	37200.8782	No.18	
<input checked="" type="checkbox"/>	PI(25:1)	25.1	PI		72644.0	18211.0	26438.2427	No.18	
<input checked="" type="checkbox"/>	PI(26:4)	26.4	PI		27754.0	8841.8	10182.8822	No.18	
<input checked="" type="checkbox"/>	PI(28:4)	28.4	PI		27388.8	88423.76	797384.1051	No.18	
<input checked="" type="checkbox"/>	PI(28:2)	28.2	PI		292288.0	43272.5191	89458.48	No.18	
<input checked="" type="checkbox"/>	PI(28:4)	28.4	PI		1482282.8	278888.8	894617.8933	No.18	

Fig. 2 Example of database search by SimLipid (Lung tissue)

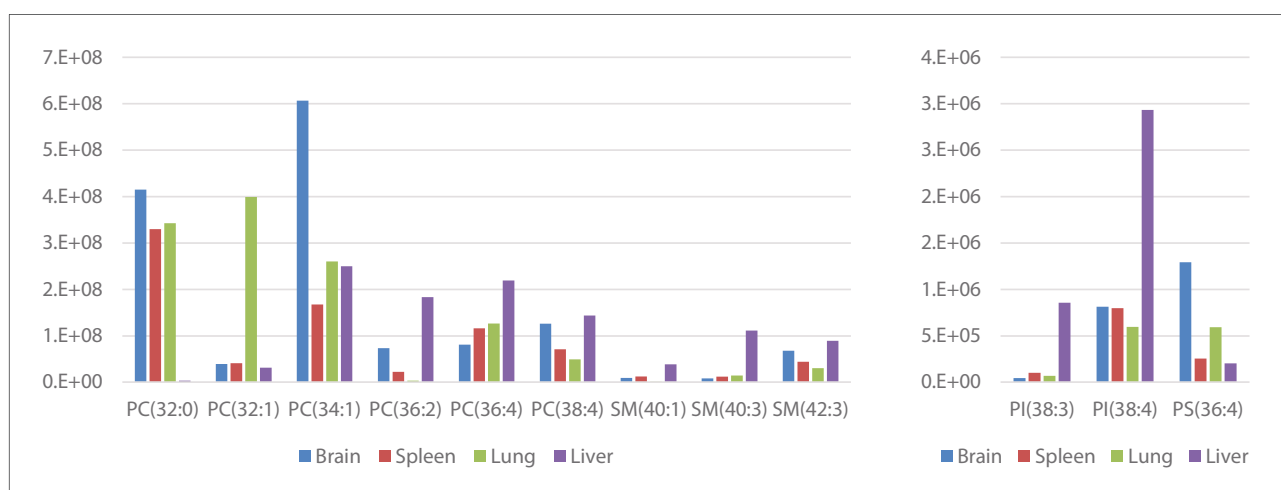

Fig. 3 "Total Abundance" of phospholipids in four tissue samples



For Research Use Only. Not for use in diagnostic procedure.

This publication may contain references to products that are not available in your country. Please contact us to check the availability of these products in your country.

The content of this publication shall not be reproduced, altered or sold for any commercial purpose without the written approval of Shimadzu. Company names, product/service names and logos used in this publication are trademarks and trade names of Shimadzu Corporation or its affiliates, whether or not they are used with trademark symbol "TM" or "®". Third-party trademarks and trade names may be used in this publication to refer to either the entities or their products/services. Shimadzu disclaims any proprietary interest in trademarks and trade names other than its own.

The information contained herein is provided to you "as is" without warranty of any kind including without limitation warranties as to its accuracy or completeness. Shimadzu does not assume any responsibility or liability for any damage, whether direct or indirect, relating to the use of this publication. This publication is based upon the information available to Shimadzu on or before the date of publication, and subject to change without notice.

# LC/MS/MS MRM Library for Phospholipid Profiling

For LabSolutions Version 5



LCMS-8060

This MRM library includes two methods: one for phospholipid classification by comprehensive analysis of the main phospholipids in biological samples, and one for fatty acid composition determination created using analytical results obtained with the classification method. The library targets phospholipids containing C14 to C22 fatty acids, and includes MRM transitions for up to 867 components.

This library enables performing phospholipid profiling by conducting an initial analysis with a phospholipid classification method. This is followed by creating a method for fatty acid composition determination based on the phospholipid peak detected in the first analysis, and subsequently using this method to perform a second analysis to determine fatty acid composition.

## Target Phospholipids

The phospholipids registered in the MRM library have fatty acid compositions with the carbon number and double bond combinations shown in the table below. The phospholipid targets of the library are phosphatidylcholines (PC) with a lyso-group, phosphatidylethanolamines (PE), phosphatidylglycerol (PG), phosphatidylinositol (PI), phosphatidylserines (PS), and sphingomyelins (SM).

Carbon Number	Number of Double Bonds					
	C14:0	C14:1				
	C16:0	C16:1				
	C18:0	C18:1	C18:2	C18:3		
	C20:0	C20:1	C20:2	C20:3	C20:4	C20:5
	C22:0	C22:1	C22:6			

## MRM Transition Composition

Focusing on the characteristic phospholipid head group, the library includes a method for phospholipid classification and a method for fatty acid composition determination (for fatty acid compositions of the given combinations) that make use of these MRM transitions.

The figure below shows each MRM transition required to identify PC (18:1/16:0). The phospholipid can be inferred by combining the analytical results obtained from these MRM transitions.

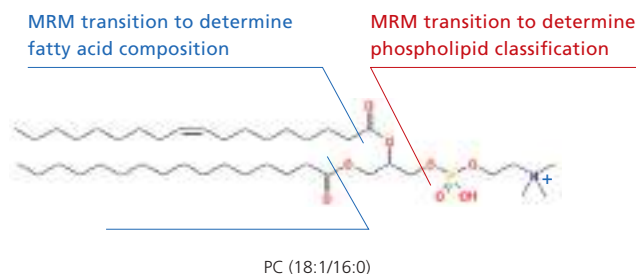

# LC/MS/MS MRM Library for Phospholipid Profiling

For LabSolutions Version 5

## Step 1

### Simultaneous Analysis Using the Phospholipid Classification Method

The phospholipid classification method is capable of comprehensive analysis of the main phospholipids in biological samples. It determines the phospholipid class based on the main characteristic head groups of phospholipids. Its analysis targets are phospholipids that include C14 to C22 fatty acids.

Type	Event#	+/-	Compound Name	m/z	Time (0.000 min - 20.000 min)
MSM	1	+	LPG 14:1	453.30	20.25
MSM	2	+	LPG 14:1	455.25	20.15
MSM	3	+	LPG 20:0	544.30	20.25
MSM	4	+	LPG 16:0	528.20	20.25
MSM	5	+	LPG 14:1	446.30	18.18
MSM	6	+	LPG 14:0	419.20	20.25
MSM	7	+	LPG 16:0	507.20	20.15
MSM	8	+	LPG 20:0	571.20	20.25
MSM	9	+	LPG 14:1	424.20	20.25
MSM	10	+	LPG 16:1	496.20	21.25
⋮					
MSM	116	-	PS 18:0	389.60	24.10
MSM	117	-	PE 14:0	341.40	24.10
MSM	118	-	PS 16:0	361.60	24.10
MSM	119	-	PE 14:0	337.50	24.10
MSM	120	-	PS 18:0	377.80	24.10
MSM	121	-	PE 14:0	343.50	24.10
MSM	122	-	PS 18:0	391.60	24.10

## Step 2

### Peak Identification

The phospholipid peak detected by the phospholipid classification method is identified. The structural information on the detected phospholipid at this point is the phospholipid class (PC, PE, PG, PI, PS, SM), and the total carbon number and number of double bonds in its constituent fatty acids. In the next step, the fatty acid composition determination method is created.

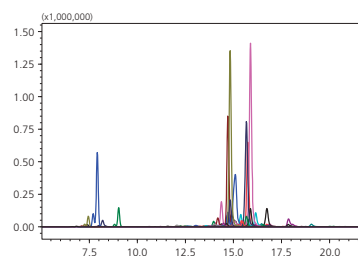

## Step 3

PC(36:1) 788.6>184.1 (+)

PC(36:1) 788.6>184.1 (+)  
 PC(14:0/22:1) 832.6>227.2 (-), 337.3 (-)  
 PC(14:1/22:0) 832.6>225.2 (-), 339.3 (-)  
 PC(16:0/20:1) 832.6>255.2 (-), 309.3 (-)  
 PC(16:1/20:0) 832.6>253.2 (-), 311.3 (-)  
 PC(18:0/18:1) 832.6>283.3 (-), 281.3 (-)

### MRM Event-Link Editor Editing the Fatty Acid Composition Determination Method

Software allows a fatty acid composition determination method to be edited from 867 MRM transitions for the phospholipid peak detected during first analysis.

## Step 4

### Simultaneous Analysis by Fatty Acid Composition Determination Method

Edited in MRM Event-Link Editor, the fatty acid composition determination method is used to perform a second analysis on the same sample. Phospholipid profiling can be performed based on the results of the first and second analysis.

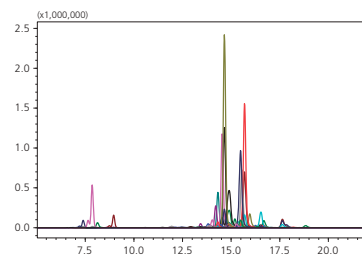

## Step 5

### Data Analysis

Based on the analysis results, it was determined that the sample contains PC (16:0/20:1) and PC (18:0/18:1), as shown in the figures below.

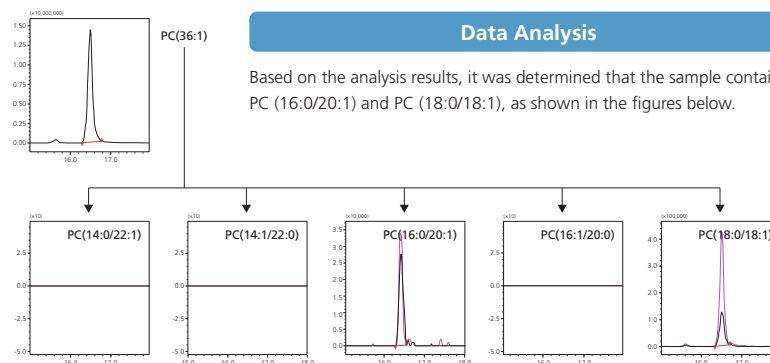

Shimadzu Corporation

www.shimadzu.com/an/

For Research Use Only. Not for use in diagnostic procedure.

This publication may contain references to products that are not available in your country. Please contact us to check the availability of these products in your country.

Company names, product/service names and logos used in this publication are trademarks and trade names of Shimadzu Corporation or its affiliates, whether or not they are used with trademark symbol "TM" or "®". Third-party trademarks and trade names may be used in this publication to refer to either the entities or their products/services. Shimadzu disclaims any proprietary interest in trademarks and trade names other than its own.

The contents of this publication are provided to you "as is" without warranty of any kind, and are subject to change without notice. Shimadzu does not assume any responsibility or liability for any damage, whether direct or indirect, relating to the use of this publication.

# Application News

## No. B61

### Imaging Mass Microscope

## A Study of Toxicity Evaluation Using the iMScope TRIO - Analysis of Localization of Amiodarone in Rat Lungs -

In drug discovery research, the analysis of the pharmacokinetics of candidate compounds provides important information not only in the elucidation of pharmacological mechanisms, but also from the viewpoint of toxicity assessment. In general, a method using autoradiography (ARG) and fluorescent dye is used, but with ARG the costs are high, and there have been concerns about the effects of using fluorescent agents as labeling agents on the pharmacokinetics. In recent years, the analytical technique of MS imaging has been attracting attention as a method that can detect data on the localization of candidate compounds without using a label. This method is expected to provide a breakthrough in drug discovery research as it can be used to analyze the localization of various substances without labeling, and to simultaneously analyze the unchanged drug and its metabolites using the same section.

Here, we introduce an example of MS imaging analysis using the iMScope TRIO imaging mass microscope (Fig. 2) to compare the localization of the pathological findings with that of the amiodarone observed in lung tissue after administering amiodarone (Fig. 1) to rats.

R. Yamaguchi, T. Yamamoto

### ■ Analysis of Localization of Amiodarone in Rat Lungs

In this experiment, we measured the tissue sections of rats lungs that had been administered amiodarone, an anti-arrhythmia drug. When administered in large quantities, amiodarone causes phospholipidosis and pathological findings such as foamy macrophage infiltration of cells are observed. However, up until now there had been no information on whether amiodarone accumulated in the lesions or not, so we examined the relationship between the pathological findings and localization of amiodarone utilizing the MS imaging technique. In the preliminary study test using standard amiodarone, we optimized the matrix selection and measurement mode, and applied those conditions in this experiment. Table 1 shows the experimental conditions from sample preparation to MS imaging analysis.

On comparing the mass spectrum taken from a tissue section obtained by performing high-resolution imaging with a spatial resolution of 5  $\mu\text{m}$  using the iMScope TRIO with the mass spectrum of the standard, a common  $m/z$  646.0 signal was detected (Fig. 3). By drawing a mass image of this  $m/z$  646.0, we confirmed that amiodarone had accumulated where foamy macrophages had infiltrated the cells (Fig. 4).

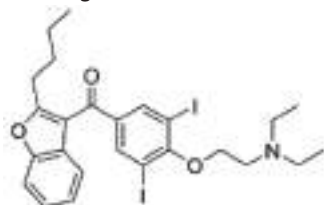

Fig. 1 Structural Formula of Amiodarone



Fig. 2 iMScope TRIO

Table 1 Experimental Conditions

Sample Preparation	
Animal species	: Rat
Administered drug	: Amiodarone hydrochloride
Administration method	: 3-day repeated oral administration
Dose	: 1000 mg/kg
Organ	: Pulmonary tissue
Section	: Fresh frozen sections
Section thickness	: 10 $\mu\text{m}$
Matrix Coating	
Matrix	: CHCA
Matrix coating method	: Sublimation by iMLayer
Matrix coating thickness	: 0.7 $\mu\text{m}$
Measurement Conditions	
Analysis instrument	: iMScope TRIO
Measurement mode	: positive mode
MS range	: $m/z$ 500-700
Laser diameter	: 5 $\mu\text{m}$
Spatial resolution	: 5 $\mu\text{m}$

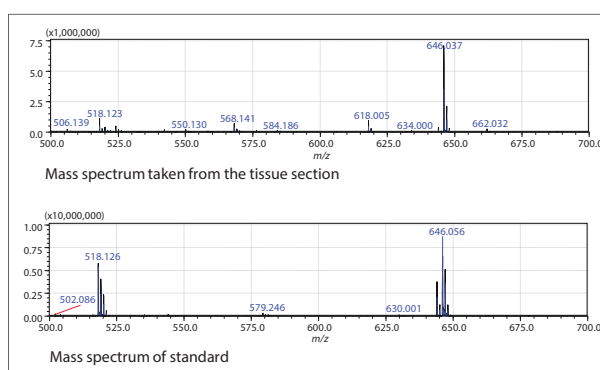

Fig. 3 Mass Spectra of the Tissue Section and Standard

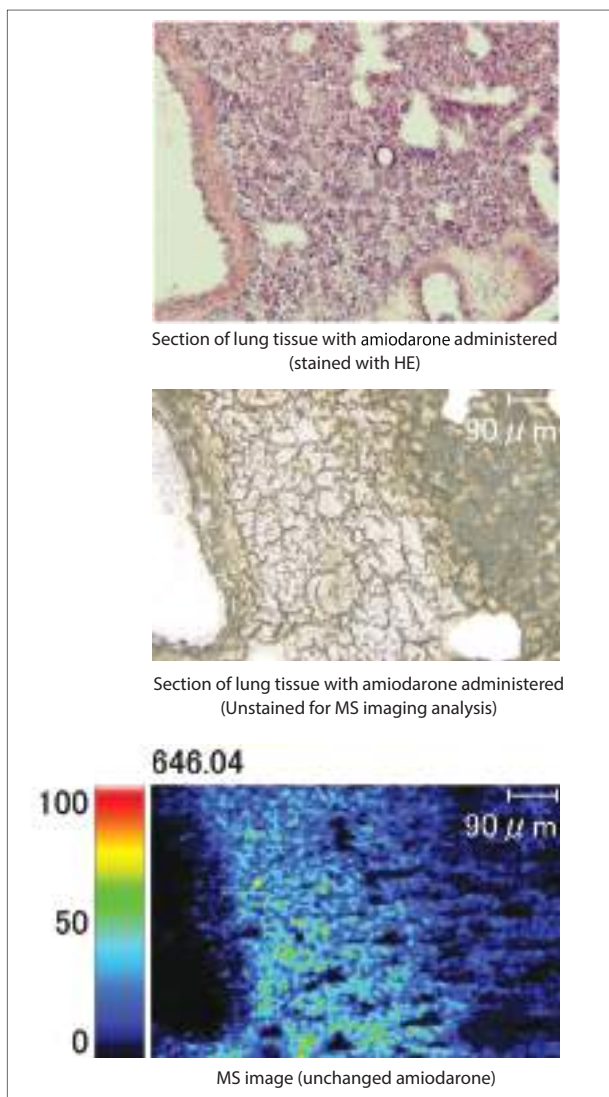

Fig. 4 HE-Stained Image and Optical Image for Analysis (Serial Sections) and MS Image

### ■ Analysis of Localization of Amiodarone Metabolites

In rats, administered amiodarone is reported to be N-deethylated in the body. In this experiment we performed MS scan analysis, and a strong peak was also observed 28 Da lower, at  $m/z$  618.0, corresponding to deethylation of unchanged amiodarone (Fig. 5). By drawing the MS image for  $m/z$  618, we obtained an image similar to that of the localization of amiodarone, as shown in Fig. 6. This also indicates a high probability that the MS image of  $m/z$  618.0 depicts a product of N-deethylation of amiodarone.

### Acknowledgments

We would like to thank Mr. Hidefumi Kaji and Mr. Hiroyuki Hashimoto of Mitsubishi Tanabe Pharma Co., Ltd. very much for their great cooperation with obtaining data for this Application News and the writing of this article.

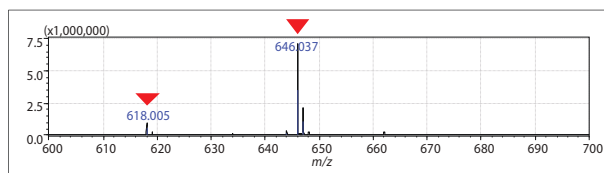

Fig. 5 Mass Spectrum of Tissue Section (Detail of  $m/z$  600 to 700 Range)

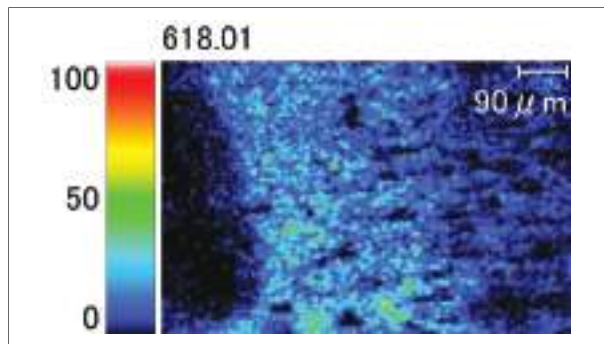

Fig. 6 MS Image (Corresponding to Molecular Weight of Metabolite)

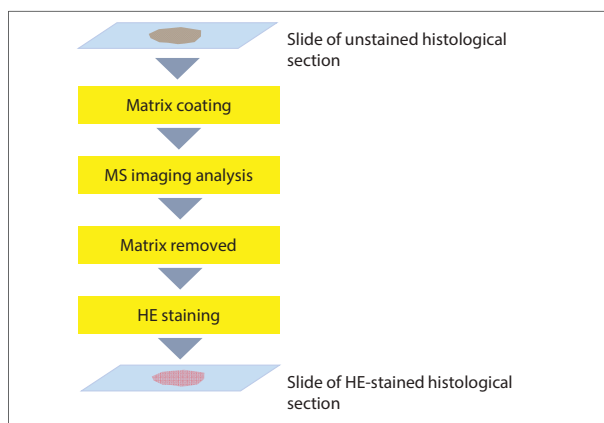

Fig. 7 Workflow for HE Staining After MS Imaging Analysis

### ■ Prospects in Perfectly Matching MS and HE-Stained Images

Since MS imaging is not possible on a section stained with HE, in this experiment MS imaging analysis was performed on an unstained section that was consecutive to the one stained with HE. However, even with serial sections the tissue morphology is only similar and not a perfect match, and the images have to be aligned by relying on distinctive landmarks. Currently, in order to solve this problem, we are considering perfectly matching the position information of the HE-stained image and MS image by removing the matrix from the section that has been subjected to MS imaging with an organic solvent and then staining it with HE, as shown in Fig. 7.

# Application News

## No. C143

### Liquid Chromatograph Mass Spectrometry

## Simultaneous Analysis of Tyrosine Kinase Inhibitors in Human Blood Plasma with LC/MS/MS

Cancer treatment in recent years employs drugs known as molecular targeted drugs that were developed to target molecules related to the growth, invasion, and metastasis of tumor cells in order to inhibit tumor cell growth.

Lung cancer treatment employs tyrosine kinase inhibitors (TKIs), which target the epidermal growth factor receptor (EGFR) and anaplastic lymphoma kinase (ALK), and new molecular targeted drugs, referred to as

second and third generation drugs, continue to be developed.

This article introduces an example of simultaneous analysis of EGFR-TKIs, ALK-TKIs, and metabolites in human blood plasma for the purpose of research into pharmacokinetics using the triple quadrupole high performance liquid chromatograph mass spectrometer LCMS-8050.

T. Tsukamoto

### Simultaneous Analysis of Four EGFR-TKIs and Three ALK-TKIs

Samples with the standard EGFR-TKIs and ALK-TKIs listed in Table 1 added to a control human blood plasma were deproteinized according to the process in Fig. 1 and the resulting supernatants were submitted

for analysis. MRM measurement with LC/MS/MS can selectively detect target drugs according to their molecular mass and structure (Fig. 2 and Fig. 3).

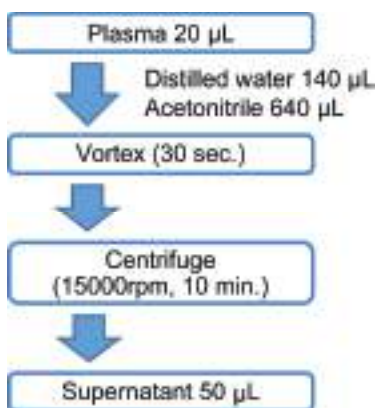

Fig. 1 Pretreatment Workflow of Blood Plasma Samples

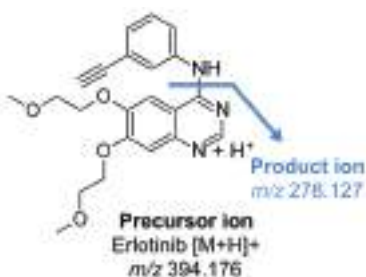

Fig. 2 Precursor Ion and Product Ion of Erlotinib

Table 1 EGFR-TKIs, ALK-TKIs, and Metabolites

	Compound	Molecular formula	Monoisotopic mass [u]	MRM transition m/z
EGFR-TKIs	Afatinib	C <sub>24</sub> H <sub>25</sub> ClFN <sub>5</sub> O <sub>3</sub>	485.163	486.2 > 371.1
	Erlotinib	C <sub>22</sub> H <sub>23</sub> N <sub>3</sub> O <sub>4</sub>	393.169	394.2 > 278.1
	OSI-420 *1	C <sub>21</sub> H <sub>21</sub> N <sub>3</sub> O <sub>4</sub>	379.153	380.2 > 278.1
	Gefitinib	C <sub>22</sub> H <sub>24</sub> ClFN <sub>4</sub> O <sub>3</sub>	446.152	447.2 > 128.1
	Osimertinib	C <sub>28</sub> H <sub>33</sub> N <sub>7</sub> O <sub>2</sub>	499.270	500.3 > 72.1
	AZ5104 *2	C <sub>27</sub> H <sub>31</sub> N <sub>7</sub> O <sub>2</sub>	485.254	486.3 > 72.2
ALK-TKIs	Alectinib	C <sub>30</sub> H <sub>34</sub> N <sub>4</sub> O <sub>2</sub>	482.268	483.3 > 396.3
	Crizotinib	C <sub>21</sub> H <sub>22</sub> Cl <sub>2</sub> FN <sub>5</sub> O	449.119	450.1 > 260.2
	Ceritinib	C <sub>28</sub> H <sub>36</sub> ClN <sub>5</sub> O <sub>3</sub> S	557.223	558.2 > 433.1

\*1 Erlotinib metabolite, \*2 Osimertinib metabolite

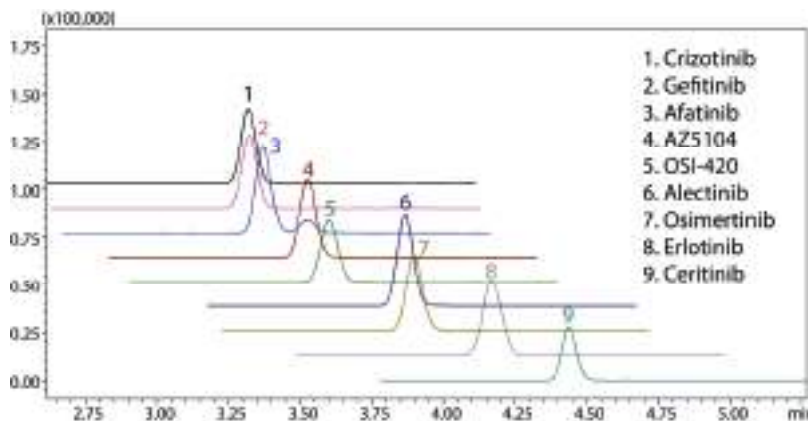

Fig. 3 Mass Chromatograms of Human Blood Plasma Samples with Standard Additives

A calibration curve was created from the control blood plasma with standards added and the integrity of accuracy and precision were evaluated. Good linearity was obtained in the set concentration range for all TKIs

and accuracy in the entire range, including the quantitative lower limit, was within 100±15 %. In the same manner, precision (%RSD) was within 15 % and good repeatability was obtained (Table 2).

**Table 2 Integrity Evaluation Results for Simultaneous Analysis of EGFR-TKIs, ALK-TKIs, and Metabolites**

Compounds	Range (ng/mL)	Accuracy (%)				Precision (%RSD, n=5)			
		LLOQ <sup>*1</sup>	Low <sup>*2</sup>	Medium <sup>*3</sup>	High <sup>*4</sup>	LLOQ <sup>*1</sup>	Low <sup>*2</sup>	Medium <sup>*3</sup>	High <sup>*4</sup>
Afatinib	5-2000	98.5	103.2	106.3	95.7	12.4	13.9	7.6	7.4
Erlotinib	5-2000	95.1	103.2	102.7	92.3	4.7	5.4	0.8	2.0
OSI-420	5-2000	95.1	104.3	103.4	91.9	9.0	2.7	2.7	3.2
Gefitinib	5-2000	93.0	110.2	103.9	93.5	12.1	6.4	3.4	1.3
Osimertinib	5-2000	94.5	107.0	103.5	93.1	4.6	3.7	2.4	1.9
AZ5104	5-2000	94.7	106.5	102.7	92.5	9.8	6.0	2.7	3.1
Alectinib	5-2000	96.9	101.4	104.0	93.1	13.4	6.3	1.8	1.9
Crizotinib	5-2000	95.4	106.1	106.6	95.3	10.9	11.1	4.1	2.5
Ceritinib	10-2000	94.4	105.2	103.6	91.6	8.0	6.7	1.7	2.8

\*1: 5 ng/mL (10 ng/mL for Ceritinib), \*2: 10 ng/mL (25 ng/mL for Ceritinib), \*3: 100 ng/mL, \*4: 1000 ng/mL

### ■ Analysis of Blood Plasma Specimens

Fig. 4 and Fig. 5 show examples of blood plasma specimen analysis. Erlotinib and the erlotinib metabolite OSI-420 were detected in specimen A and alectinib was detected in specimen B. Like the control blood plasma used to create the calibration curve, no significant

interference by impurities in the blood plasma was observed for either specimen.

This analysis method that uses LC/MS/MS is expected to be utilized as an analysis technique for TKIs in blood plasma specimens.

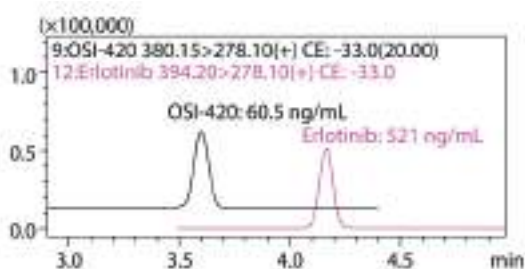

**Fig. 4 Analysis Result of Blood Plasma Specimen A**

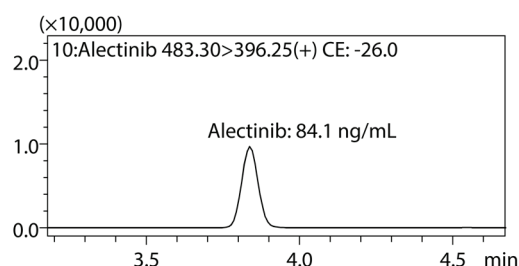

**Fig. 5 Analysis Result of Blood Plasma Specimen B**

**Table 3 Analysis Conditions**

Column	: Shimadzu GLC Mastro C18 (100 mm L. × 2.1 mm I.D., 3 μm)	Injection Volume	: 3 μL
Mobile Phase	: A 10 mmol/L Ammonium formate buffer - water, B Acetonitrile		
Flow Rate	: 0.3 mL/min		
Time program	: B Conc. 10 % (0 min) – 100 % (5 – 7 min) – 10 % (7.01 – 10 min)		
Column Temp.	: 50 °C		
Probe Voltage	: 1.0 kV (ESI-positive mode)	DL Temp.	: 250 °C
Interface Temp.	: 300 °C	Nebulizing Gas Flow	: 3 L/min
Block Heater Temp.	: 400 °C	Drying Gas Flow	: 10 L/min
Heating Gas Flow	: 10 L/min		

### <Acknowledgments>

We would like to thank pharmacist Reiko Makihara of the Pharmacy Division at the National Cancer Center Hospital of Japan (National Research and Development Agency) for her significant cooperation in the investigation provided in this document.

- References
- Guidance for Industry : Bioanalytical Method Validation (2001, US FDA)
  - Guideline on Bioanalytical Method Validation in Pharmaceutical Development (2013, Ministry of Health, Labour and Welfare, Japan)

- Notes
- The product described in this document has not been approved or certified as a medical device under the Pharmaceutical and Medical Device Act of Japan.
  - It cannot be used for the purpose of medical examination, treatment or related procedures.
  - The specimens described in this document were all sampled and measured at the National Cancer Center Hospital. Permission was obtained in accordance with proper procedures regarding the publication of measurement data.

First Edition: Mar. 2017



**For Research Use Only. Not for use in diagnostic procedure.**

This publication may contain references to products that are not available in your country. Please contact us to check the availability of these products in your country.

The content of this publication shall not be reproduced, altered or sold for any commercial purpose without the written approval of Shimadzu. Company names, product/service names and logos used in this publication are trademarks and trade names of Shimadzu Corporation or its affiliates, whether or not they are used with trademark symbol "TM" or "®". Third-party trademarks and trade names may be used in this publication to refer to either the entities or their products/services. Shimadzu disclaims any proprietary interest in trademarks and trade names other than its own.

The information contained herein is provided to you "as is" without warranty of any kind including without limitation warranties as to its accuracy or completeness. Shimadzu does not assume any responsibility or liability for any damage, whether direct or indirect, relating to the use of this publication. This publication is based upon the information available to Shimadzu on or before the date of publication, and subject to change without notice.

Shimadzu Corporation

www.shimadzu.com/an/

# Application News

## No. L464

### High Performance Liquid Chromatography

## Ultra-High Speed Analysis of USP Methods Conforming to Permissible Limits in New USP General Chapter 621

In the General Chapter <621> Chromatography of the U.S. Pharmacopeia (USP), the ranges within which changes to HPLC and GC parameters are permissible are indicated, and as long as the values are within that range, and as long as the system suitability requirements are satisfied, the method can be changed without revalidation. An example of a faster method by which these changes remained within the permissible range was previously introduced in Application News No. L448. The General Chapter 621 was again revised, and the revision has been in effect as of August 1, 2014. Previously, a reduction of up to 50 % in the column particle size was permitted, but according to the new revisions to the General Chapter 621 that has been in effect, the column particle size can be freely selected. Therefore, even though the current particle size of 5 μm is specified, columns with particle size in the sub-2 μm region may be used, permitting even faster analyses. Here, we introduce an example of a faster analysis of a USP method in compliance with the new General Chapter 621 using the Nexera X2 ultra high performance liquid chromatograph and the Shim-pack XR-ODS III high-speed analytical column.

\*Shimadzu Scientific Instruments, Inc., USA

#### ■ Permissible Limits of Modification for HPLC Parameters

Tables 1 and 2 list the permissible limits of the HPLC column-related parameters according to the General Chapter 621 of the previous and new version of the specifications, respectively. These changes apply to the column length, particle size, and flowrate. It should be noted that these changes apply only to isocratic analysis, and are not applicable to gradient analysis.

**Table 1 Permissible Limits of HPLC Parameters in the Previous General Chapter 621 (effective until July 31, 2014)**

Column diameter	Can be adjusted if the linear velocity is kept constant
Column length	Can be adjusted by as much as ±70 %
Particle size	Can be reduced by as much as 50 %, but cannot be increased.
Flowrate	Can be adjusted based on column cross-sectional area ratio. In addition, can be adjusted by ±50 %.

**Table 2 Permissible Limits of HPLC Parameters in the New General Chapter 621 (effective as of August 1, 2014)**

Column diameter	Can be adjusted if the linear velocity is kept constant
Column length and particle size	May be modified provided that the ratio of the column length ( <i>L</i> ) to the particle size ( <i>dp</i> ) remains constant or within the range of -25 % to +50 % of the prescribed <i>L/dp</i> ratio.
Flowrate	Can be adjusted using column cross-sectional area ratio and particle size inverse ratio.* When a change is made from ≥3 μm particle size to <3 μm particle size, or from <3 μm particle size to ≥3 μm particle size, the linear velocity may be changed within a range in which the column efficiency does not decrease more than 20 %.* In addition, it can be adjusted by ±50 %.

\* See text

This change is based on the theory that if *L/dp* is kept constant, equivalent separation performance will be maintained. For example, if a column of length 150 mm and particle size of 5 μm (*L/dp* = 150,000 μm / 5 μm = 30,000) is changed to one of column length 50 mm and particle size 1.6 μm (*L/dp* = 31,250), *L/dp* can be maintained at +4.2 %, thereby obtaining equivalent separation performance. In addition, the following formula can be used with respect to flowrate.

$$F_2 = F_1 \times [(dc_2^2 \times dp_1) / (dc_1^2 \times dp_2)]$$

*F*<sub>1</sub> and *F*<sub>2</sub> express the original USP monograph flowrate and the modified flowrate, respectively. Also, *dc* and *dp* express the column internal diameter and column packing particle size, respectively. This expression includes two principles. The first is that the flowrate is adjusted in proportion to the column cross-sectional area, or in other words, the linear velocity is kept constant. The second is that because the particle size and optimal flowrate are inversely proportional, the point is to change the flowrate in inverse proportion to the particle size. For example, the USP monograph stipulates that for a 4.6 × 150 mm, 5 μm column, a flowrate of 1.0 mL/min is specified, and if the column is changed to a 2.0 × 50 mm, 1.6 μm column, a flowrate of 0.59 mL/min is required. Further, if the particle size is changed from ≥3 μm to <3 μm, it is permissible to increase the flowrate further as long as the column efficiency does not decrease more than 20 %. Conversely, if a <3 μm particle size is changed to ≥3 μm, the flowrate may need to be decreased so that the column efficiency does not decrease more than 20 %.

#### ■ Speed Enhancement of a USP Method

Here, we introduce a faster method of the impurity analysis of sulfacetamide as defined in the USP. Sulfacetamide is a type of sulfonamide antibacterial drug. The column specified in the USP for this analysis is the 4.6 × 150 mm, 5 μm, L1 (ODS), using a flowrate of 0.8 mL/min. In this case, if the 2.0 × 50 mm, 1.6 μm, L1, Shim-pack XR-ODS III column is used, almost the same *L/dp* value is obtained. The flowrate can be calculated as 0.47 mL/min from the formula just introduced. Although analysis of a system suitability test solution, a standard solution, and the sample solution are all required in an actual analysis, here we show the chromatograms obtained from analysis of system suitability test solutions (0.2 mg/mL USP sulfacetamide reference standard, 0.05 mg/mL USP sulfanilamide USP reference standard). For the HPLC system, the Prominence was used, and for the UHPLC system, the Nexera X2 was used. Table 3 shows the analytical conditions, Fig. 1 shows the chromatograms obtained, and Table 4 shows the system suitability test results. Using the Nexera X2 system and the Shim-pack XR-ODS III column, in addition to meeting the system suitability requirements, we were able to shorten the analysis time significantly. In this investigation, not only was the analysis shortened to about 1/10 the time on a per-minute basis, solvent consumption was also reduced to about 1/15 that normally required.



**Table 3 Analytical Conditions**

System	: (1) Prominence (2) Nexera X2 (Loop injection with 20 $\mu$ L loop)
Column	: (1) Shim-pack VP-ODS (150 mm L. $\times$ 4.6 mm I.D., 4.6 $\mu$ m) (2) Shim-pack XR-ODS III (50 mm L. $\times$ 2.0 mm I.D., 1.6 $\mu$ m)
Mobile Phase	: Methanol / water / acetic acid = 10/89/1 (v/v/v)
Column Temp.	: Ambient
Flowrate	: (1) 0.8 mL/min (2) 0.47 mL/min
Injection Vol.	: (1) 10 $\mu$ L (2) 2 $\mu$ L
Detection	: (1) SPD-20AV at 254 nm (2) SPD-M30A at 254 nm
Flow Cell	: (1) Conventional cell (for SPD-20A(V)) (2) Standard cell (for SPD-M30A)

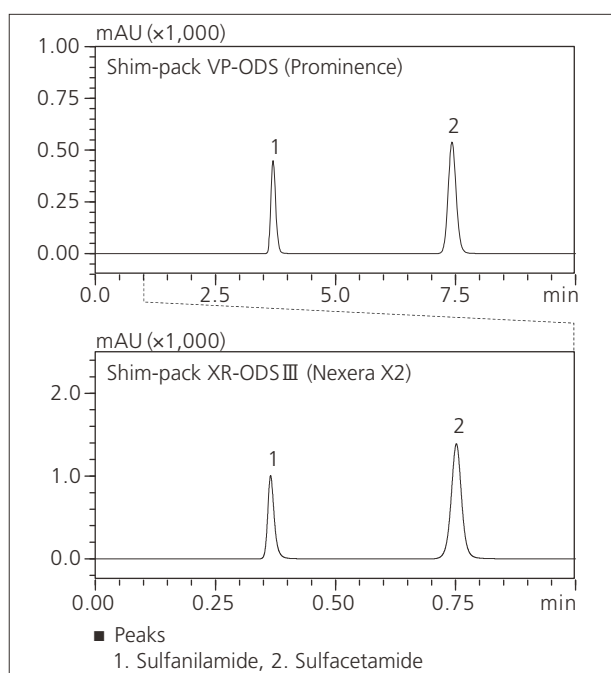

**Fig. 1 Chromatograms of System Suitability Test Solution**  
(Upper: VP-ODS with Prominence, Lower: XR-ODS III with Nexera X2)

**Table 4 Results of System Suitability Test**

System suitability requirements		VP-ODS (Prominence)	XR-ODS (Nexera X2)
USP resolution between sulfacetamide and sulfanilamide	$\geq 5.0$	14.54	12.23
USP tailing factor for sulfacetamide	$\leq 1.5$	1.09	1.04
Relative standard deviation for sulfacetamide	$\leq 2.0$ %	Rt 0.015 %	Rt 0.037 %
		Area 0.067 %	Area 0.103 %

**■ A USP Method Performed on Nexera X2**

Next, this example shows how analysis of a timolol maleate ophthalmic solution is conducted using the Nexera X2 without changing the analytical conditions specified in the USP. Timolol maleate is a type of non-selective  $\beta$ -blocker. Table 5 shows the analytical conditions used, Fig. 2 shows the chromatogram of the standard solution (0.136 mg/mL timolol maleate) obtained, and Table 6 shows the system suitability test results. Even using the Nexera X2 UHPLC system, it is clear that analysis equivalent to that using the Prominence HPLC system is easily achieved without any problem.

**Table 5 Analytical Conditions**

System	: (1) Prominence (2) Nexera X2 (Loop injection with 20 $\mu$ L loop)
Column	: Shim-pack VP-ODS (150 mm L. $\times$ 4.6 mm I.D., 4.6 $\mu$ m)
Mobile Phase	: Sodium phosphate buffer <pH 2.8> / methanol = 65/35 (v/v)
Column Temp.	: 40 $^{\circ}$ C
Flowrate	: 1.2 mL/min
Injection Vol.	: 10 $\mu$ L
Detection	: (1) SPD-20AV at 295 nm (2) SPD-M30A at 295 nm
Flow Cell	: (1) Conventional cell (for SPD-20A(V)) (2) Standard cell (for SPD-M30A)

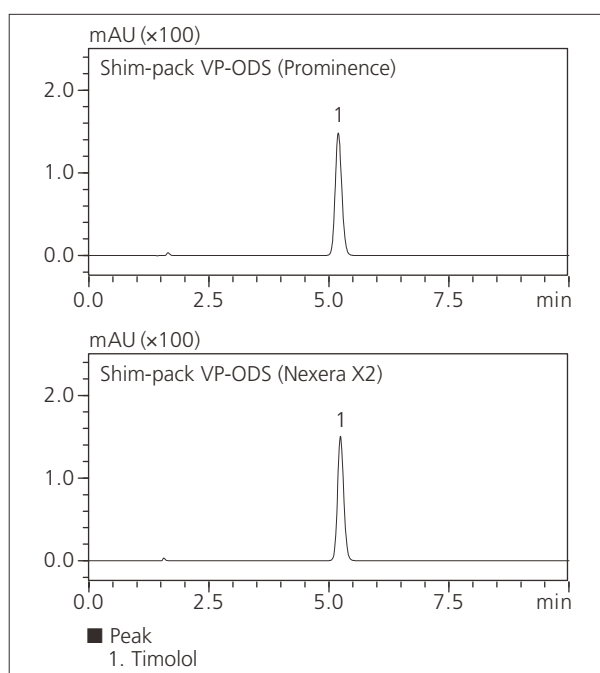

**Fig. 2 Chromatograms of Standard Solution**  
(Upper: VP-ODS on Prominence, Lower: VP-ODS on Nexera X2)

**Table 6 Results of System Suitability Test**

System suitability requirements		VP-ODS (Prominence)	VP-ODS (Nexera X2)
USP tailing factor	$\leq 2.0$	1.12	1.11
USP column efficiency	$\geq 3600$	6354	6965
Relative standard deviation	$\leq 2.0$ %	Rt 0.027 %	Rt 0.082 %
		Area 0.034 %	Area 0.062 %

**■ Conclusion**

This study demonstrated that, in accordance with the new USP General Chapter 621, even higher-speed analysis is possible with the Shim-pack XR-ODS III and Nexera X2. Also, because the Nexera X2 can be used not only for UHPLC analysis, but for HPLC analysis as well, it is also suitable for those who are running traditional USP methods on a standard HPLC system, and are considering the adoption of a UHPLC system for higher-speed analysis of USP methods in the future..

[References]

- USP General Chapter 621, USP 37-NF 32, First supplement
- USP Monograph, Sulfacetamide, USP 37-NF 32, First supplement
- USP Monograph, Timolol maleate ophthalmic solution, USP 37-NF 32, First supplement



# Application News

## No. L494

### High Performance Liquid Chromatography

## Analysis of Omeprazole by "i-Series" for USP and JP Methods

Omeprazole, a drug that effectively suppresses the excessive secretion of gastric acid, is often used for the treatment of gastric ulcer and duodenal ulcer, in addition to the treatment of reflux esophagitis. Acting as a Proton Pump Inhibitor (PPI), omeprazole is included in the WHO Model List of Essential Medicine, and considered an important component of basic medical care.

This Application News introduces an example of analysis of omeprazole in accordance with the Japanese Pharmacopoeia (JP) and the United States Pharmacopoeia (USP). Also presented here is an example of analysis that can be completed in a significantly shorter time than that described in the USP General Chapter 621 Chromatography.

The Nexera-i integrated UHPLC was used for the analysis by the procedure described in the USP. The Nexera-i supports the use of analytical conditions specified for both HPLC and UHPLC. In the case of compliance (HPLC conditions) with the Japanese Pharmacopoeia, we conducted analysis using the Prominence-i integrated HPLC.

### ■ The USP Method - Original Method

The analytical conditions specified in the USP monograph are shown in Table 1. The results of analysis of the system suitability test solution (0.1 mg/mL, acetonitrile-boric acid solution) specified in the omeprazole test method are shown in the upper chromatogram of Fig. 1. The results obtained sufficiently satisfy the threshold required with respect to both tailing factor and relative standard deviation (n = 6) specified in the monograph (Table 4).

**Table 1 Analytical Conditions (USP Original Method)**

System	: Nexera-i
Column	: Shim-pack GIST C8 (150 mmL. × 4.6 mm I.D., 5 μm)
Mobile Phase	: Acetonitrile/Phosphate (Na) Buffer (pH 7.6) = 1/3 (v/v)
Flowrate	: 0.80 mL/min
Column Temp.	: 40 °C
Injection Volume	: 20 μL
Detection	: UV 280 nm (Cell temp. 40 °C)

**Table 2 Selection of Column for Speed Enhancement**

	Column Size	L/dp	Ratio
USP Original Method	150 mmL. × 4.6 mm I.D., 5 μm	30000	1 (100 %)
USP Fast Method	50 mmL. × 3.0 mm I.D., 2 μm	25000	0.83 (-17 %)

**Table 3 Analytical Conditions (USP Fast Method)**

System	: Nexera-i
Column	: Shim-pack GIST C8 (50 mmL. × 3.0 mm I.D., 2 μm)
Mobile Phase	: Acetonitrile/Phosphate (Na) Buffer (pH 7.6) = 1/3 (v/v)
Flowrate	: 0.85 mL/min
Column Temp.	: 40 °C
Injection Volume	: 8 μL
Detection	: UV 280 nm (Cell temp. 40 °C)

### ■ Speed Enhancement for USP Method

The permissible ranges within which the analytical conditions may be modified are specified in the USP General Chapters: <621> Chromatography. Changing these analytical conditions within range makes it possible to shorten the analysis time. For details regarding changes that can be used to allow fast USP-compliant analysis, please refer to Application News L464.

Shortening analysis time can be accomplished in two ways, 1) by shortening the column, and 2) by increasing the flowrate (linear velocity). To preserve the resolution of the column, the column length and particle size may be modified as long as the ratio of L (column length) to dp (column particle size) remains in the specified range (permissible range: -25 % to +50 %). We selected a column size of 50 mmL. × 3.0 mm I.D., and 2 μm particle size. For further details, please see Table 2. The flowrate, proportional to the column cross-sectional area, and inversely proportional to the particle diameter (see text for permissible limits), was determined as 0.85 mL/min.

The instrument used for the analysis was the Nexera-i high-speed integrated UHPLC, suitable for multi-sample processing. The Nexera-i permits analysis using both HPLC and UHPLC conditions, without requiring changes to plumbing or flow cell type. This flexibility can allow legacy HPLC methods to be quickly transferred to UHPLC speed and performance.

Table 3 shows the analytical conditions using the higher speed analysis, and the chromatogram obtained from analysis of the system suitability test solution is shown in the lower part of Fig. 1. The analysis time was reduced more than 80 percent compared to that using the analytical conditions of Table 1 (Fig. 1 upper).

The results of the system suitability test are shown in Table 4. Clearly, the threshold value has been satisfied even using high-speed analysis conditions.

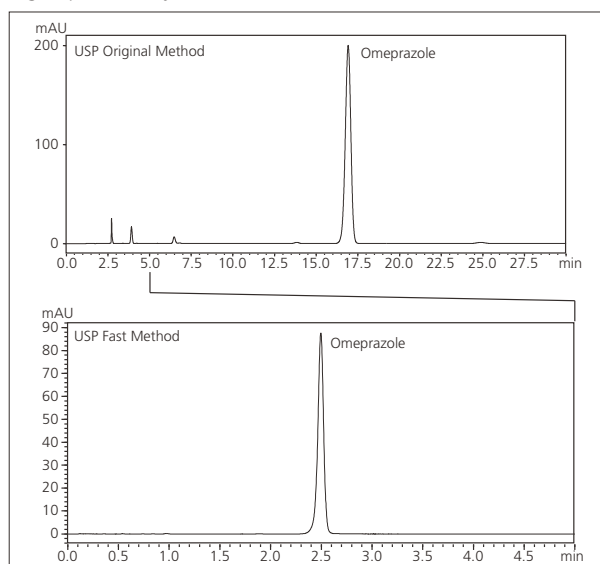

**Fig. 1 Chromatograms Conforming to USP Method (Upper: USP Original Method, Lower: USP Fast Method)**

**Table 4 Results of System Suitability Test Using USP Method (Original Method and Fast Method)**

System Suitability Requirements		Analytical Conditions			
		USP Original Method (Table 1)		USP Fast Method (Table 3)	
		Results	Judgments	Results	Judgments
USP Tailing Factor for Omeprazole	$\leq 1.5$	0.94	PASS	0.89	PASS
Relative Standard Deviation for Omeprazole (n = 6)	$\leq 1.0 \%$	Rt 0.097 %	PASS	Rt 0.081 %	PASS
		Area 0.022 %	PASS	Area 0.121 %	PASS

**■ Analysis According to Japanese Pharmacopeia**

The analytical conditions specified in the 16th Edition of the Japanese Pharmacopeia are shown in Table 5. For the instrument, the integrated HPLC Prominence-i was used. The system suitability test specified in the Japanese Pharmacopeia includes three items, "Test for required detectability", "System performance", and "System repeatability". The respective chromatograms are shown in Figs. 2-4.

Regarding the test for required detectability, both the system suitability test solution (5 mg/L, prepared using mobile phase) and this solution diluted five-to-one with mobile phase are measured, and their peak areas compared. The peak area of the omeprazole in the five-to-one diluted solution was compared to the results obtained using the system suitability solution, and was determined to be approximately 20 % (within permissible range of 15-25 %).

For evaluation of system performance, omeprazole and 1,2-dinitrobenzene are dissolved in sodium borate-ethanol solution (at 100 mg/L and 250 mg/L, respectively). The solution is analyzed, and the resolution of omeprazole and 1,2-dinitrobenzene is verified. The results indicated a resolution of about 24 (permissible range is 10 or greater).

For evaluation of system repeatability, six repeat analyses of the system suitability test solution were conducted, and the peak area relative standard deviation was checked. A relative standard deviation of 0.2 % was obtained (permissible range is 2.0 % or less).

These results are summarized in Table 6.

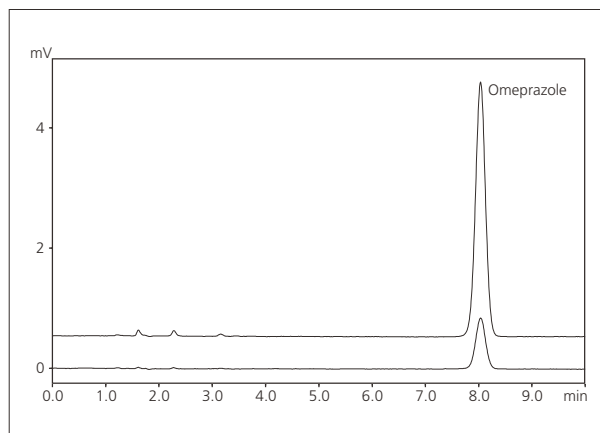

**Fig. 2 Chromatogram According to JP Method – Test for Required Detectability (Upper: 5 mg/L, Lower: 1 mg/L)**

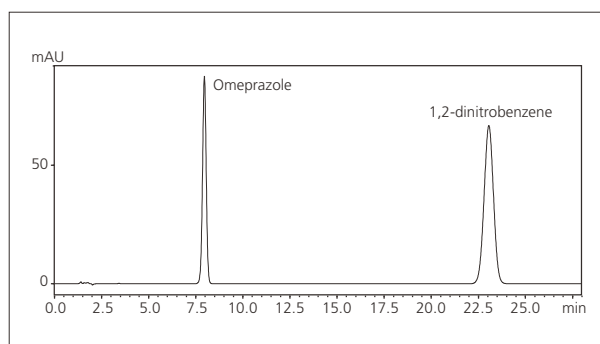

**Fig. 3 Chromatogram According to JP Method – System Performance**

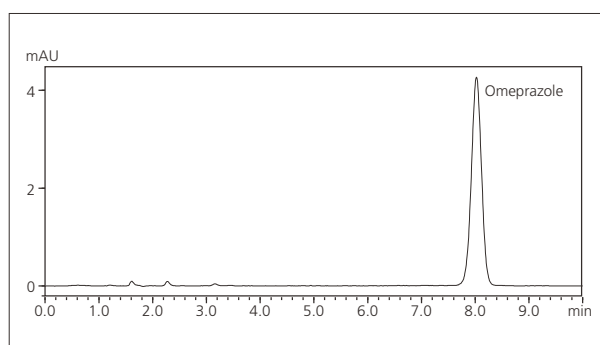

**Fig. 4 Chromatogram According to JP Method – System Repeatability**

**Table 5 Analytical Conditions (JP Method)**

System	: Prominence-i
Column	: Shim-pack GIST C8 (150 mmL, x 4.6 mm I.D., 5 μm)
Mobile Phase	: Phosphate (Na) Buffer (pH 7.6) / Acetonitrile = 29/11 (v/v)
Flowrate	: 1.3 mL/min
Column Temp.	: 25 °C
Injection Volume	: 10 μL
Detection	: UV 280 nm (Cell temp. 40 °C)

**Table 6 Results of System Suitability Test (JP Method)**

System Suitability Requirements		Results	Judgments
Test for Required Detectability	Area 15 to 25 %	19.7 %	PASS
System Performance	Resolution $\geq 10$	23.6	PASS
System Repeatability	%RSD Area $\leq 2.0 \%$	0.202 %	PASS

# Application News

## No. L518

### High Performance Liquid Chromatography

## High Speed Analysis of Pharmaceutical Impurities in Compliance with European Pharmacopoeia Using Nexera-i MT

In recent years, the development of short-time analytical methods for improving analytical task efficiency and productivity is promoting the uptake of an ultra-high-speed analytical technology that uses UHPLC systems and columns packed with microparticles in research and development departments in the pharmaceutical field. This trend also applies to pharmacopoeia. For example, according to "Adjustment of chromatographic condition"<sup>1</sup> described in the 8th edition of the European Pharmacopoeia (EP), adjustments to parameters in TLC, LC, GC and SFC are only allowed when the system suitability requirements are satisfied. In such a case, revalidation is not required.

This article introduces an example of high speed analysis of pharmaceuticals and related substances in compliance with the EP using the Nexera-i MT integrated high performance liquid chromatograph.

N. Iwata

### Allowable Adjustment Range of HPLC

The LC section in "Adjustment of chromatographic condition" is broadly classified into isocratic elution and gradient elution.

For gradient elution, the allowable adjustment range of methods differs from that of isocratic elution because peak-shifting caused by unstable gradient profile of the mobile phase can lead to misidentification and overlapping of multiple peaks. For example, in terms of column particle size, while a reduction of up to 50% is possible for isocratic elution, particle size cannot be adjusted for gradient elution. Furthermore, in the case of gradient elution, it is stated that the elution time of the principal peak must be within  $\pm 15\%$  of that in the testing method. Thus, the adjustments of many parameters are restricted for gradient elution and further high speed analysis is practically impossible. Therefore high speed analysis can only be achieved for isocratic elution.

### High Speed Analysis of Ivermectin and Related Substances

Ivermectin, belonging to macrolides, is known as a therapeutic drug for strongyloidiasis, an antiscabietic and an antiparasitic agent for animals. The two main components of ivermectin are H<sub>2</sub>B<sub>1a</sub> (molecular weight: 875) and H<sub>2</sub>B<sub>1b</sub> (molecular weight: 861). The former makes up more than 90 % of its composition.

**Table 1 Analytical Conditions**

System	: Nexera-i MT
Column 1 (Conventional)	: Shim-pack GIST C18 (250 mm L, 4.6 mm I.D., 5 $\mu$ m)
Flow rate 1	: 1.0 mL/min
Column 2 (High speed)	: Shim-pack GIST C18 (150 mm L, 4.6 mm I.D., 3 $\mu$ m)
Flow rate 2	: 1.5 mL/min
Mobile phase	: A) Water B) Methanol C) Acetonitrile A/B/C=15/34/51 (v/v/v)
Column temp.	: 25 °C
Injection volume	: 20 $\mu$ L
Detection	: UV254 nm

In this research we examined reducing the analysis time within the adjustment range allowed by the EP. Table 1 lists the analytical conditions that comply with both the ivermectin related substances testing section<sup>2</sup> and the allowable adjustment range assigned in the EP. Since the Nexera-i MT used in analysis features both HPLC and UHPLC flow lines, it allows migration between conventional analysis and high speed analysis within a single system. The Shim-pack GIST C18 series was used for the analytical columns. The analytical conditions other than the analytical columns and flow rate are the same as those listed in the EP.

Fig. 1 shows resulting chromatograms of ivermectin standard solution (0.8 mg/mL). The high speed analysis provided approximately 60 % and 40 % reductions of analysis time and mobile phase consumption respectively while maintaining enough separation. Table 2 shows the results of system suitability test. Both conventional analysis and high speed analysis passed the test.

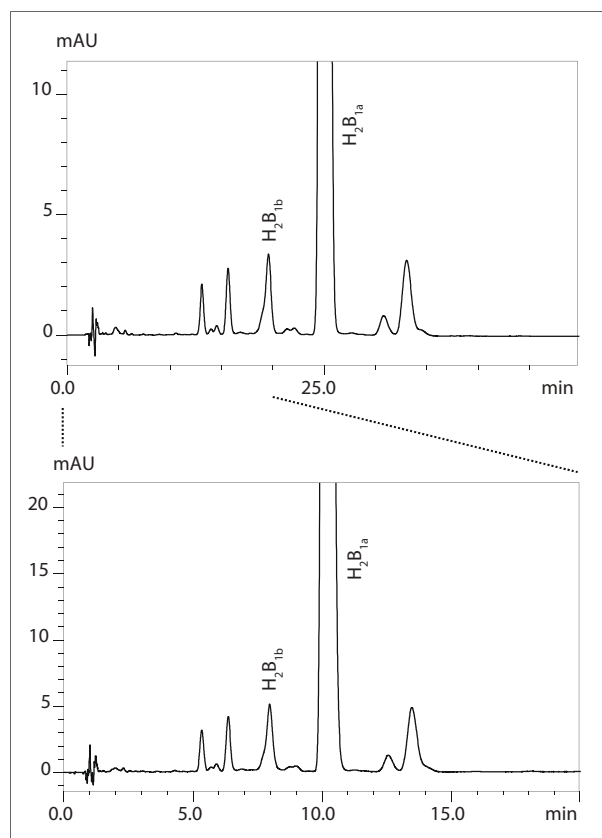

**Fig. 1 Chromatograms of Ivermectin Standard Solution**  
Upper: Conventional Analysis Using HPLC Flow Line (Column 1)  
Lower: High Speed Analysis Using UHPLC Flow Line (Column 2)

**Table 2 Results of System Suitability Test**

System suitability requirements	Results		Judgements	
	Conventional	High speed		
Resolution (H <sub>2</sub> B <sub>1b</sub> and H <sub>2</sub> B <sub>1a</sub> )	≥ 3.0	5.1	4.7	PASS
Signal-to-noise ratio (0.4 µg/mL)	≥ 10	40	38	PASS
Symmetry factor	≤ 2.5	1.1	1.2	PASS

### High Speed Analysis of Diclofenac Sodium and Related Substances

Diclofenac is widely used as an antipyretic and a pain-reliever. Here we introduce an example of high speed analysis of a diclofenac sodium and related substances based on the EP.

Fig. 2 shows the resulting chromatograms of diclofenac standard solution (1.0 mg/mL). Table 3 lists the analysis conditions that comply with both the testing section<sup>\*3</sup> of diclofenac sodium related substances and the allowable adjustment range assigned in the EP. The analytical columns used in conventional analysis and high speed analysis were both the same as those used in the analysis of ivermectin. A commercially-available reagent for system suitability testing was used as the reference standard.

In conventional analysis, the mobile phase flow rate assigned in the EP is 1.0 mL/min. Despite adjusting the flow rate to 0.8 mL/min in this research due to the column pressure tolerance, which is within the allowable adjustment range, the obtained results meet the system suitability requirements (Table 4). High speed analysis also passed the system suitability test. The high speed analysis provided approximately 70 % and 40 % reductions of analysis time and mobile phase consumption respectively while maintaining enough separation.

As demonstrated above, Nexera-i MT not only facilitated migration from conventional analysis to high speed analysis but also provided results of an equal level.

**Table 3 Analytical Conditions**

System	: Nexera-i MT
Column 1 (Conventional)	: Shim-pack GIST C18 (250 mm L, 4.6 mm I.D., 5 µm)
Flow rate 1	: 0.8 mL/min
Column 2 (High speed)	: Shim-pack GIST C18 (150 mm L, 4.6 mm I.D., 3 µm)
Flow rate 2	: 1.4 mL/min
Mobile phase	: A) Sodium phosphate buffer (pH 2.5) B) Methanol A/B=34/66 (v/v)
Column temp.	: 25 °C
Injection volume	: 20 µL
Detection	: UV 254 nm

**Table 4 Results of System Suitability Test**

System suitability requirement	Results		Judgement	
	Conventional	High speed		
Resolution (impurity F and Diclofenac)	≥ 4.0	6.8	5.1	PASS

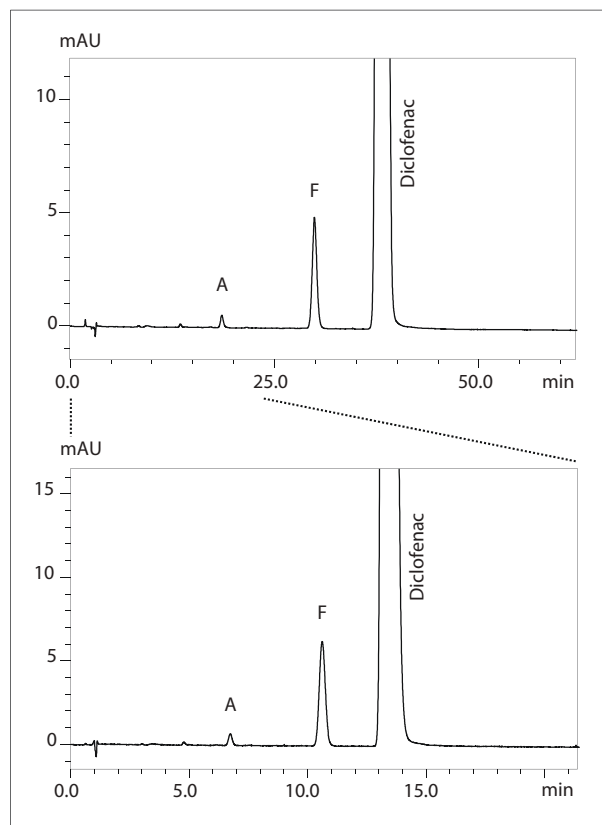

**Fig. 2 Chromatograms of Diclofenac Standard Solution**  
Upper: Conventional Analysis Using HPLC Flow Line (Column 1)  
Lower: High Speed Analysis Using UHPLC Flow Line (Column 2)

#### <References>

- \*1 European Pharmacopoeia 8.0, 04/2009:20246 2.2.46. Chromatographic separation techniques
- \*2 European Pharmacopoeia 8.8, 04/2016:1336 "Ivermectin"
- \*3 European Pharmacopoeia 8.8, 07/2014:1002 "Diclofenac sodium"

# Application News

## No. L520

### High Performance Liquid Chromatography

## Analysis of Montelukast Sodium Using Prominence-i and Nexera-i MT

Montelukast sodium is used as a therapeutic drug for treating bronchial asthma and allergic rhinitis, and is listed in the 17th edition of the Japanese Pharmacopoeia (JP). The JP is aiming for international harmonization with the US Pharmacopoeia (USP) and European Pharmacopoeia (EP), and descriptions for this drug have already been harmonized between the USP and EP. Therefore, the testing methods described in the JP are based on this harmonized content. Structural formulae of impurities and flow rates used for analysis are clearly indicated, showing how the tests should be from now on.

This article introduces system suitability tests of montelukast sodium using Prominence-i and Nexera-i MT in compliance with the 17th edition of the JP.

K. Nakajima, Y. Osaka

### ■ Analysis of Montelukast Sodium Using Prominence-i

A system suitability test was conducted according to the quantitative method for montelukast sodium (Fig. 1) described in the JP.

Solution A (1 mg/mL) for peak identification was prepared using the montelukast standard for system suitability tests. Solution B for peak identification was then prepared by taking 1 mL of solution A into a clear vial and allowing to stand it for 20 minutes. Table 1 lists the analytical conditions of solution B. The obtained chromatogram using Prominence-i is shown in Fig. 2 and indicates that the related substances listed in the JP are also identified. Table 2 shows results of the system suitability test.

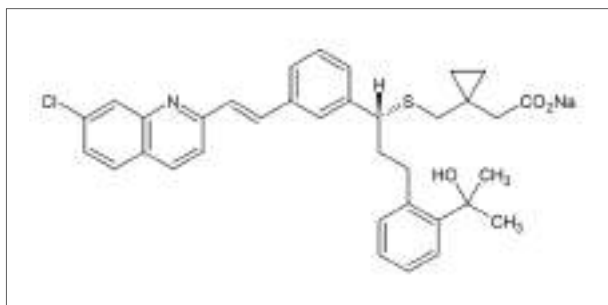

Fig. 1 Structural Formula of Montelukast Sodium

Table 1 Analytical Conditions

Column	: Phenyl silyl silica gel column (50 mm L. × 4.6 mm I.D., 1.8 μm)
Flow rate	: 1.2 mL/min
Mobile phase	: A) Water/Trifluoroacetic acid = 2000/3 (v/v) B) Acetonitrile/Trifluoroacetic acid = 2000/3 (v/v)
Time program	: B Conc. 40 % (0 min) → 40 % (3 min) → 51 % (16 min)
Column temp.	: 30 °C
Detection	: UV 238 nm (Cell temp. 40 °C)
Injection vol.	: 10 μL

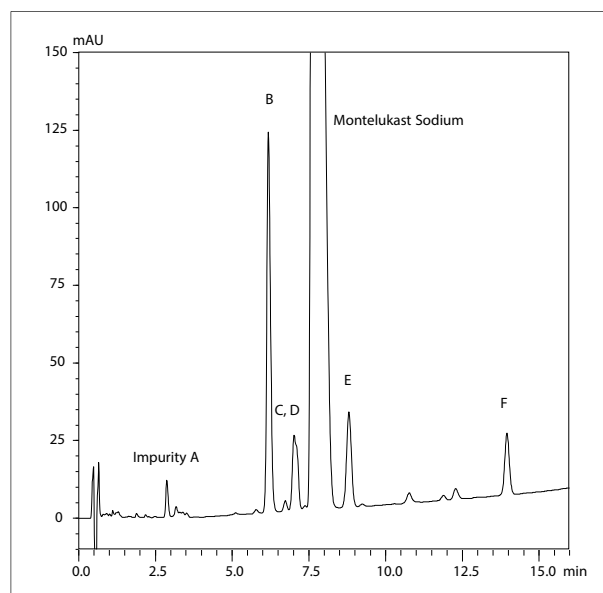

Fig. 2 Chromatogram of Montelukast Sodium Standard for System Suitability Test Using Prominence-i

Table 2 Results of System Suitability Test (Prominence-i)

System Suitability Requirements	Results	Judgements
Resolution (Montelukast Sodium and Impurity B)	≥ 2.5 3.8	PASSED
Resolution (Montelukast Sodium and Impurity E)	≥ 1.5 2.8	PASSED
System Repeatability (% RSD Area)	≤ 0.73 % 0.27	PASSED

### ■ Analysis of Montelukast Sodium Using Nexera-i MT

Nexera-i MT has two flow channels of HPLC and UHPLC and enables method switching from HPLC to UHPLC within a single instrument. In this analysis, montelukast sodium was analyzed using the HPLC channel of Nexera-i MT. The obtained chromatogram is shown in Fig. 3 and indicates that the related substances listed in the JP are also identified. Table 3 shows results of the system suitability test.

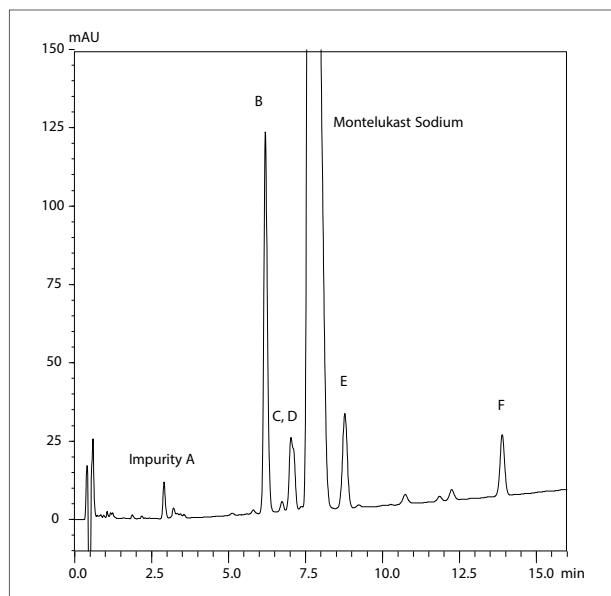

**Fig. 3 Chromatogram of Montelukast Sodium Standard for System Suitability Test Using Nexera-i MT**

**Table 3 Results of System Suitability Test (Nexera-i MT)**

System Suitability Requirements		Results	Judgements
Resolution (Montelukast Sodium and Impurity B)	≥ 2.5	3.8	PASSED
Resolution (Montelukast Sodium and Impurity E)	≥ 1.5	2.8	PASSED
System Repeatability (% RSD Area)	≤ 0.73 %	0.21	PASSED

### ■ Correction of System Volume Utilizing the ACTO Function

Here we introduce an example of method transfer from another LC system using the ACTO (Analytical Condition Transfer and Optimization) function, which is a standard feature of the Shimadzu integrated liquid chromatograph "i-Series" and work station "LabSolutions".

If an analytical method on an existing LC system is transferred to another LC system, the retention time may not be identical due to the difference in dwell volume, pump specifications, etc. In such a case, the gradient start time adjustment function, which is a feature in the ACTO function, can be executed to adjust the gradient start time for the specified volume.

Fig. 4 (a) shows the chromatogram obtained using Prominence-i and Fig. 4 (b) shows the one obtained using Nexera-i MT's HPLC channel. In the analysis using Nexera-i MT, the gradient start time adjustment function was enabled to correct the difference in volume between the systems, thereby obtaining a chromatogram congruent with that from Prominence-i. (Table 4)

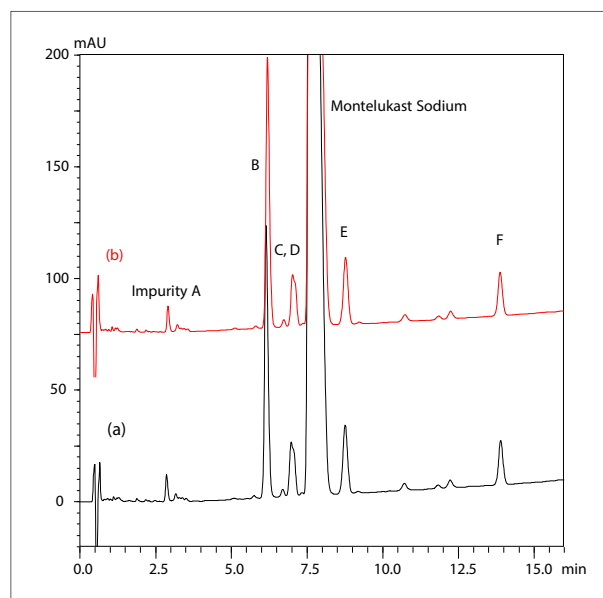

**Fig. 4 Method Transfer Example Using Gradient Start Time Adjustment Function (a) Prominence-i (b) Nexera-i MT**

**Table 4 Difference in Retention Time (%) between Prominence-i and Nexera-i MT**

Component	Before Gradient Adjustment	After Gradient Adjustment
Impurity A	1.3	1.1
Impurity B	2.7	0.3
Impurity C, D	3.1	0.2
Montelukast Sodium	2.7	-0.1
Impurity E	2.8	-0.1
Impurity F	2.5	-0.3

First Edition: Jul. 2017



Shimadzu Corporation

www.shimadzu.com/an/

**For Research Use Only. Not for use in diagnostic procedure.**

This publication may contain references to products that are not available in your country. Please contact us to check the availability of these products in your country.

The content of this publication shall not be reproduced, altered or sold for any commercial purpose without the written approval of Shimadzu. Company names, product/service names and logos used in this publication are trademarks and trade names of Shimadzu Corporation or its affiliates, whether or not they are used with trademark symbol "TM" or "®". Third-party trademarks and trade names may be used in this publication to refer to either the entities or their products/services. Shimadzu disclaims any proprietary interest in trademarks and trade names other than its own.

The information contained herein is provided to you "as is" without warranty of any kind including without limitation warranties as to its accuracy or completeness. Shimadzu does not assume any responsibility or liability for any damage, whether direct or indirect, relating to the use of this publication. This publication is based upon the information available to Shimadzu on or before the date of publication, and subject to change without notice.

## Application News

No. LC-15-ADI-036

Ultra fast Purification Liquid Chromatography

### Isolation and identification of Atorvastatin degradation impurities by UFPLC

#### Introduction:

Atorvastatin is an antilipemic drug belonging to the statins class, whose reference drug is Pfizer's Lipitor® (shown in Figure 1). It is used to reduce the levels of lipoproteins rich in cholesterol and reduce the risk of coronary artery disease. The drug in question is commonly sought after by pharmaceutical industries that produce generic drugs, due to the fact that the drug has a high value price, it is consumed globally, and its patent expired in late 2010. Atorvastatin has been found to degrade under acid and basic conditions.

Prominence UFPLC, Ultra Fast Preparative and Purification Liquid Chromatograph (Shown in Figure 2.), enables fast recovery of highly purified target compounds from complex samples such as organic synthesis reaction mixtures and natural products. Preparative LC (Prep LC) is a widely used technique in many research developments and manufacturing applications, including the synthesis of new drug compounds and the discovery of active components in natural products. It is mostly used to collect large amounts of unknown compounds in foods and drugs for subsequent structural analysis.

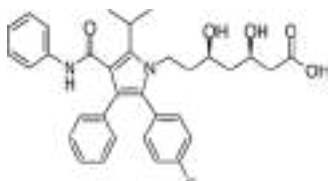

Figure 1. Atorvastatin



Figure 2. UFPLC

#### Features

##### i. Comprehensive Automation of Preparative LC, Concentration, Purification, Elution, Collection and Powderization Only in 1.5 Hours

- ✓Dedicated automation software to assist chemists in preparative procedure through collection
- ✓The time of evaporation can be reduced by up to 90% because of collection with organic solvent.

##### ii. High Purity as a Free Base

- ✓Removal of counter ions derived from preparative mobile phase
- ✓De-salting and conversion to free base with ammonia/water

##### iii. Small Footprint and Low-initial-cost

- ✓Your lab space can be kept with high functionality by small footprint
- ✓Available in two standard configurations to match your requirements
  - Standard system with one trapping column
  - Advanced system with five trapping columns

#### Experimental:

##### Acid Degradation

200 mg of Atorvastatin API sample was dissolved in 10 mL of methanol and added 10 mL of 0.1 N hydrochloric acid and kept at 80°C for 1 hr. After degradation, added a few mL of methanol to dissolve residue and diluted to 10 mL. This solution was used for analysis on UFPLC for fraction collection. 10 µL of the solution was taken and diluted with 1mL of acetonitrile/water (1:1) to make 200 mg/L and then injected into HPLC

##### Analytical Conditions

Mobile phase A	: 0.1% TFA in water
Mobile phase B	: Acetonitrile
Gradient program	: (0.01/ 40, 10.00/50, 15.00/70 20.00/90, 25.00/90, 30.00/40 35.00/40) (Time in mins /B%)
Column	: Shim-pack GIS C-18 (250X10mm, 5µ)
Flow Rate	: 5.0 ml/min
Wavelength	: 245 nm

#### Preparation for Analysis

The degradation sample was diluted with methanol to make the clear solution. After dilution the sample concentration was 10 g/L. Before UFPLC analysis diluted samples were analyzed on Nexera system to check the extent of degradation. The fast method was developed on Shim-pack XR-ODS-II on Nexera X2 system to check the purity of degradation samples and fractions collected by UFPLC.

#### Results and Discussion

Automation of preparative LC, concentration, purification, elution and collection controlled by dedicated automation software (see page 3) assists chemists in clearly identifying the peaks which are trapped and collected in specific color code. 1D chromatogram is shown in Figure 3 and corresponding area percentages are given in Table 1:Area Percentage

Peak#	Name	Ret. Time	Area	Area%
1	Atorvastatin	4.421	14932410	27.214
2	Impurity H	5.449	17169678	31.292
3	Unknown imp	6.032	22767800	41.494

The UFPLC system is capable of trapping maximum 5 peaks in one injection run on 5 different trap columns. It also rinses the individual trap columns by different rinsing solution to remove salts. It ensures that the compounds are transferred into free bases before they are eluted.



The trap column can retain compounds of different polarity due to its large retention capacity. Additionally, rinsing the column with ammonia/water after trapping allows compounds to be recovered as free bases, which are generally easier to powderize and typically yields greater quality result when used in drug screening and pharmacokinetic studies.

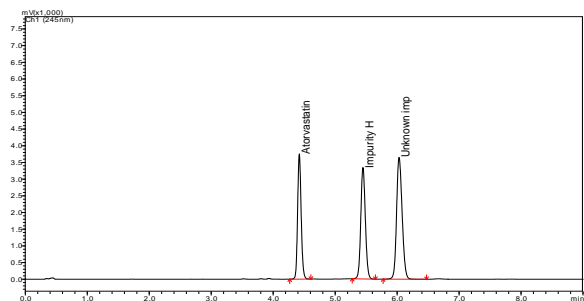

Figure 3. Crude

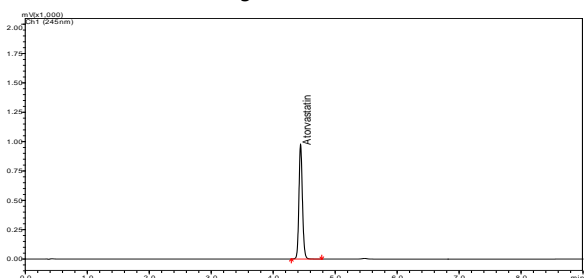

Figure 4. Peak 1

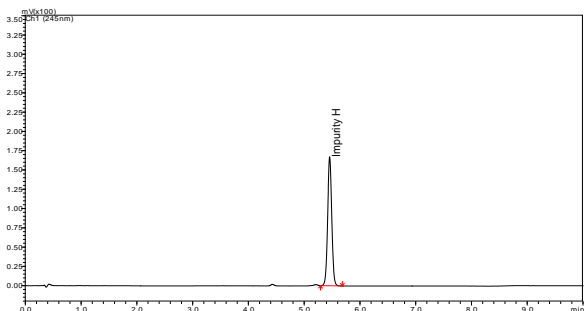

Figure 5. Peak 2

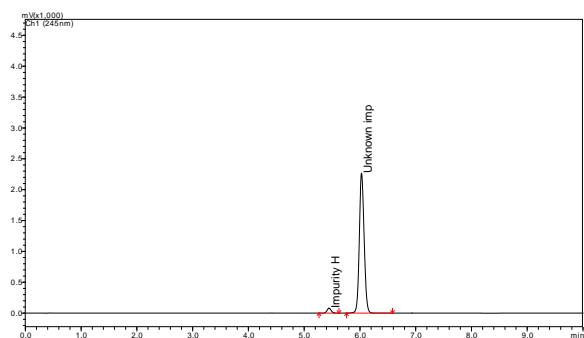

Figure 6. Peak 3

Atorvastatin degradation solution was injected into UFPLC to collect different impurity peak. The fractions were collected as free bases after online rinsing and desalting. The collected fractions of individual peaks were injected on Nexera X2 UHPLC system to check the purity. The individual chromatograms are shown in Figure 4, 5 and 6. The degradation solution was also injected on LCMSMS as shown in Figure 7 to check the  $m/z$  of degradation impurities. The collected purified fractions were also injected into LCMS to confirm the  $m/z$  of the impurities.

The individual chromatograms are shown in Figure 8, 9 and 10. The two degradation impurities showed  $m/z$  of 541.30 and 573.20. These peaks were further subjected to product ion scan to see the structural similarity among Atorvastatin and impurities (Figure 11 and 13). The fragmentation patterns (Figure 12 and 14) of both the impurities are identical after  $m/z$  318.10 which indicate the structural similarities between them.

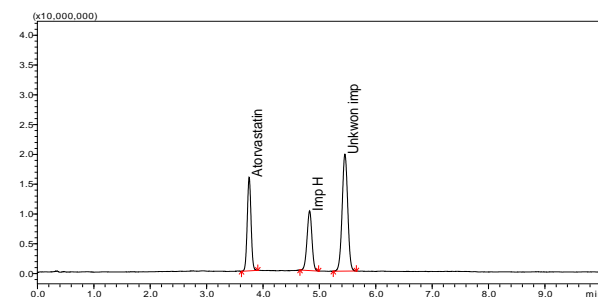

Figure 7. Extracted TIC of crude degradation sample

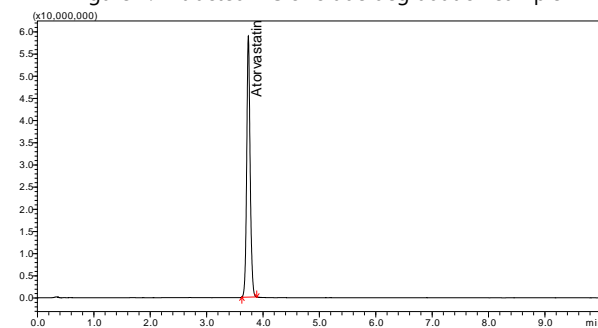

Figure 8. Extracted TIC of Atorvastatin

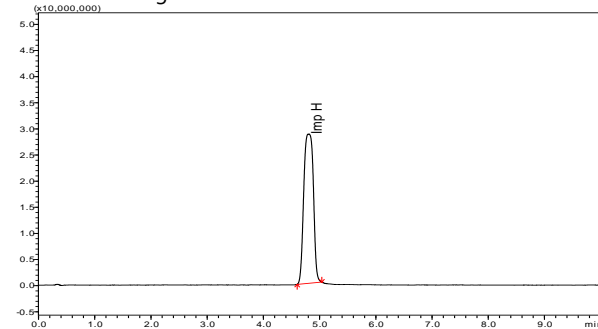

Figure 9. Extracted TIC of imp H

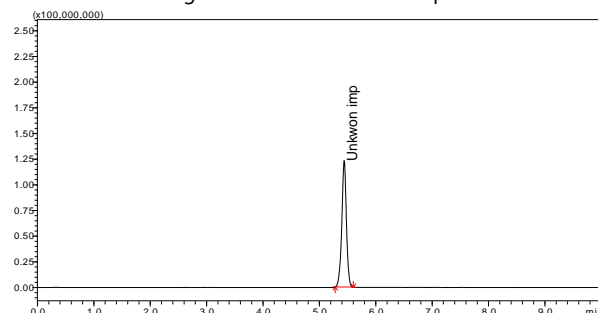

Figure 10. Extracted TIC of Unknown imp

The Prominence UFPLC system utilizes Shimadzu's proprietary purification technology that shortens the time required for fractionation, concentration, purification, and recovery, to about 90 minutes from the conventional eight hours or more (shown in figure 15). The system also enables the recovery of high-purity target compounds. The Prominence UFPLC greatly improves the efficiency of preparative fraction collection and purification workflows in pharmaceutical, food, chemical and other industries as well as research organizations.

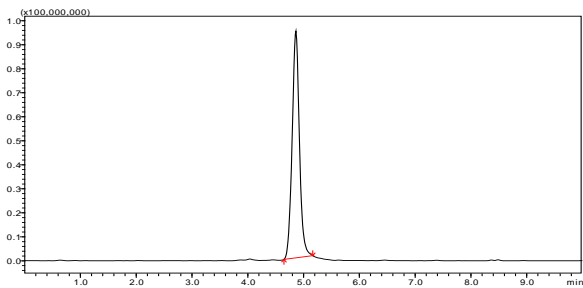

Figure 11. TIC of Product ion scan, imp H

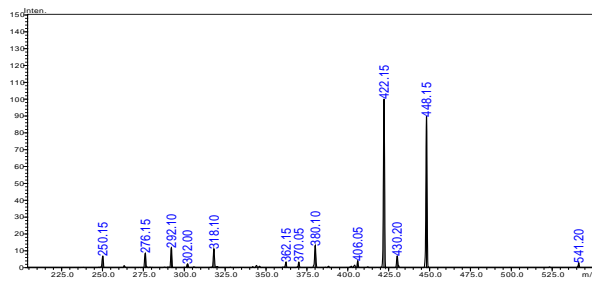

Figure 12. MS/MS spectrum of imp H

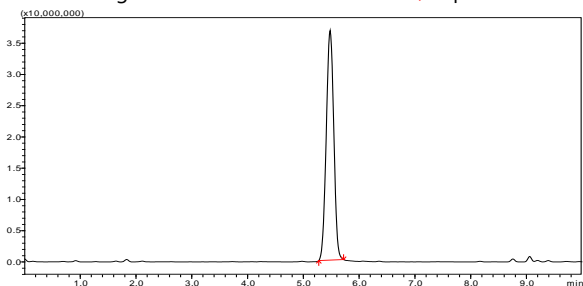

Figure 13. TIC of Product ion scan, unknown imp

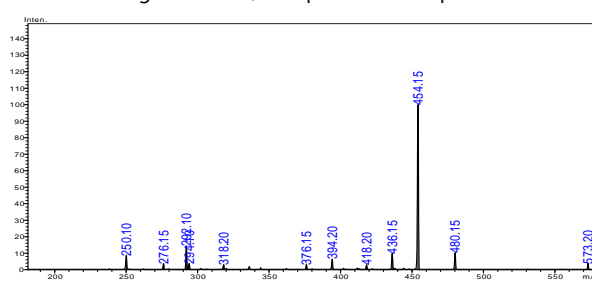
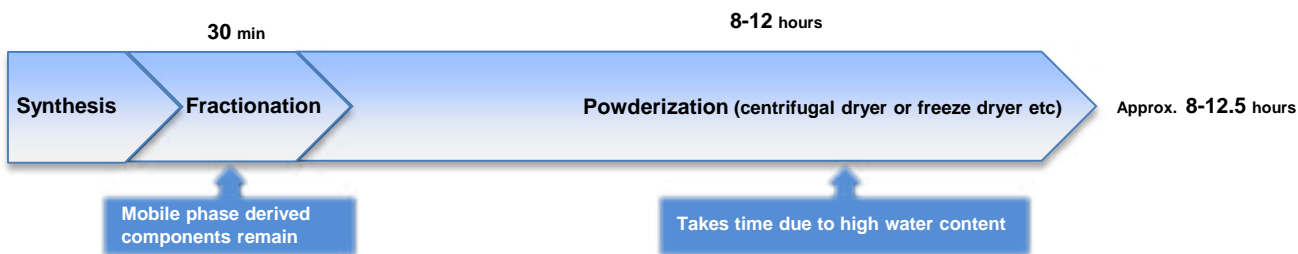

Figure 14. MS/MS spectrum of unknown imp

>>Existing method



>>Prominence UFPLC

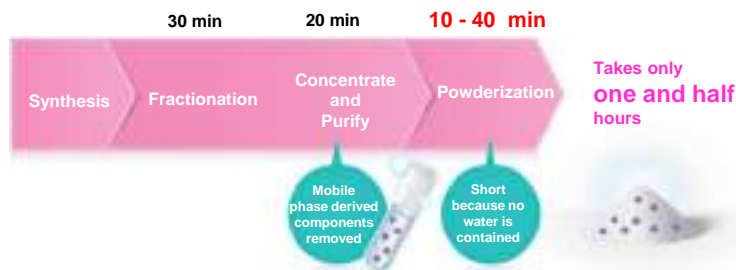
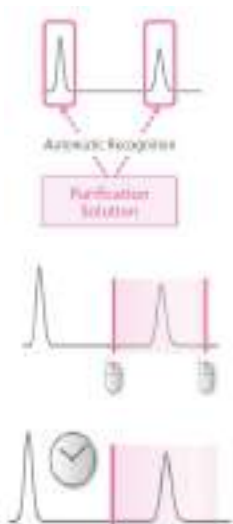

Figure 15. UFPLC purification cycle

With the dedicated Purification Solution software, the analysis status can be quickly confirmed at a glance using the peak tracking function.

To ensure reliable fractionation and purification of precious samples, the Purification Solution software offers three fractionation modes



#### **Automatic Fractionation Mode**

In this mode, the software automatically identifies peaks and collects fractions based on parameter settings.

#### **Manual Fractionation Mode**

In this mode, the mouse pointer is used to fractionate peaks while viewing the window. When the same sample is concentrated by repeated injections, the first fractionation range is saved then the second and subsequent samples are automatically fractionated using the same fractionation range.

#### **Time-Specified Fractionation Mode**

This mode collects fractions based on the retention times in previously acquired data. It is ideal for routinely performed preparative purification processes.

#### **□Conclusion**

The Prominence UFPLC seamlessly integrates traditional Prep LC with novel fraction trapping for up to five compounds of interest. The instrument is controlled by a dedicated walk-up software designed to empower non-expert users to easily set conditions for chromatographic separation and isolation of target compounds, trapping, purifying, eluting and collecting highly purified compounds in as little as 90mins. For applications involving the isolation of low concentration targets, repeated injection and collection to the same trapping column to increase the amount of compound trapped on column prior to elution is easily accomplished.

The Prominence UFPLC eliminates some of the problems associated with conventional Prep LC, especially poor purity of collected compounds due to mobile phase additives, which become contaminants in the final collected fraction and inhibit powderization. Shimadzu's "Shim-pack C2P-H" trap column strongly retains target compounds allowing unwanted organic solvents, water and additives to be flushed away in very quick time.

# Application News

## No.L495

### Supercritical Fluid Chromatography

## Automated Optimization of Chiral Separation Parameters Using Nexera UC Chiral Screening System

Chiral compounds contain asymmetric carbons in their molecules and are not superimposable on their mirror images. HPLC has been the main method used to separate such chiral compounds, but in recent years, the use of supercritical fluid chromatography (SFC) has been gaining attention. The main mobile phase used for chiral SFC is supercritical carbon dioxide, with low polarity, low viscosity, and high diffusivity, to which polar organic solvents (modifiers) are added to control solubility and polarity. Therefore, chiral compound separation by HPLC, which generally uses normal phase conditions, offers the potential for high speed, low organic solvent consumption, low cost, and low environmental impact. However, chiral SFC requires selecting a variety of separation parameters, such as columns and modifiers, which can involve large amounts of time and effort. This article describes using the Nexera UC chiral screening system to automatically optimize the large number of separation parameters by switching between up to 12 columns and various mixture ratios of four types of modifiers. This can significantly reduce the effort required.

### ■ Separation Parameters for the Chiral Screening System

Model sample: The structure of omeprazole is shown in Fig. 1. Daicel CHIRALPAK®/CHIRALCEL® series 12 columns for chiral analysis were used for the analysis. These columns offer a line of complementary stationary phase columns that are able to separate a wide variety of chiral compounds. When used in combination with the Nexera UC chiral screening system, which features a method scouting function, optimal chiral separation parameters can be determined easily. In addition, three types of modifiers were used, methanol, ethanol, and a mixture of acetonitrile and ethanol. Details about the separation parameters are indicated in Table 1. The optimal parameters for chiral separation were comprehensively selected from the total of 36 possible combinations of modifiers (3 types) and columns (12 types).

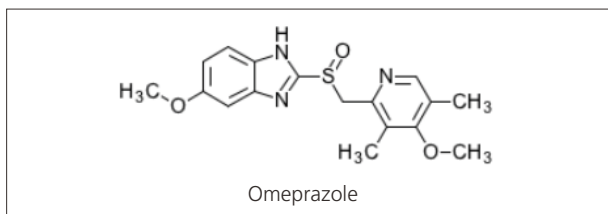

Fig. 1 Sample Used to Evaluate the Method Scouting Function

Table 1 Analytical Conditions

Column	: CHIRALPAK®, CHIRALCEL® Series 100 mm L. × 3.0 mm I.D., 3 μm
Mobile Phase	: A; Super critical fluid of CO <sub>2</sub> B; Modifier: Methanol, Ethanol, mixture of Acetonitrile: Ethanol = 3:1 (v:v)
Time Program	: B Conc. 20 % (0 - 8 min) → 40 % (8 - 10 min) → 20 % (10 - 14 min)
Flowrate	: 3 mL/min
Column Temp.	: 40 °C
Injection Volume	: 2 μL
BPR Pressure	: 10 Mpa
Detector	: Photodiode Array Detector (Max Plot 210 - 400 nm)



Fig. 2 Method Scouting Solution Operating Screen for Nexera UC

### Automated Optimization of Chiral Separation Parameters for Omeprazole

Fig. 3 shows the results from a total of 36 possible combinations of 12 chiral columns and 3 types of modifiers (methanol, ethanol, and acetonitrile/ethanol mixture).

For omeprazole, separation of peaks for two chiral forms were confirmed within 8 minutes of retention. Fig. 4 shows the separation evaluation and optimal parameter

ranking results from the optional software. The software automatically ranks all the chromatograms with separation greater than a given criteria (in this case, 1.5). This confirmed the utility of using the Nexera UC chiral screening system to automatically optimize separation parameters for chiral SFC, which otherwise requires a complicated process of selecting analytical conditions.

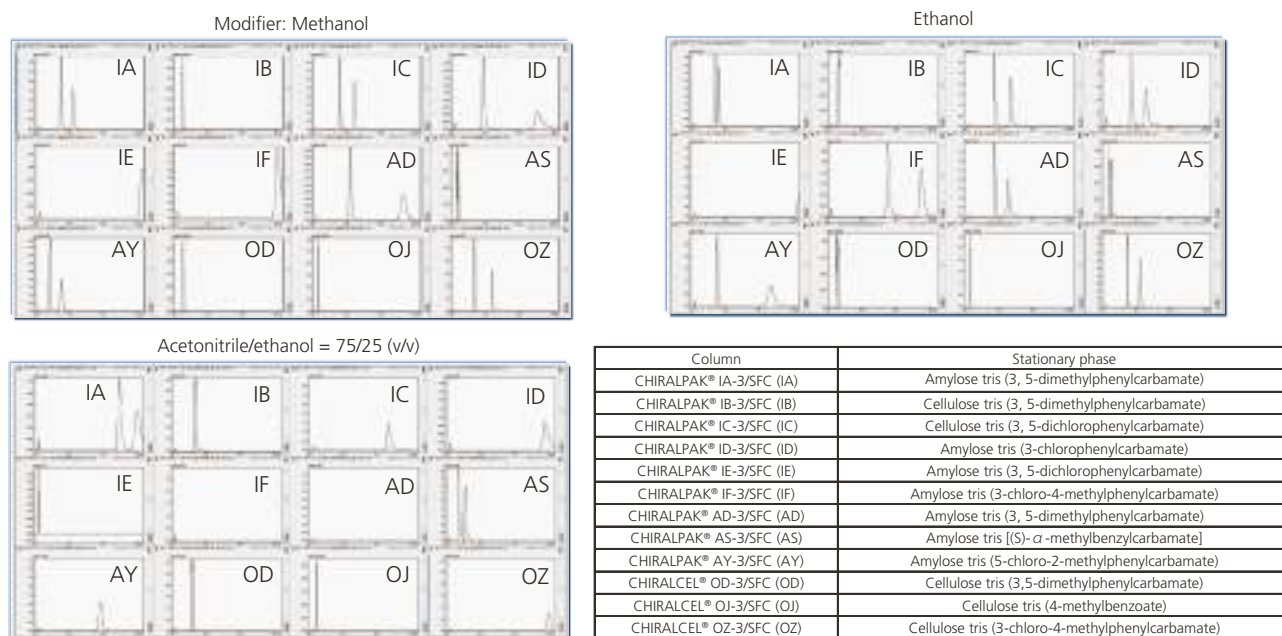

Fig. 3 Comparison of Separation Using Different Combinations of 12 Chiral Columns and 3 Modifiers

Ranking	Run No.	Analytical Condition	Resolution	Separation factor	Symmetry factor		Retention factor		Area%		Peak number
					Peak1	Peak2	Peak1	Peak2	Peak1	Peak2	
1	32	Omeprazole_OZ-3_MeOH_20_40	7.965	1.921	1.16	1.159	6.583	12.644	49.829	50.171	2
2	17	Omeprazole_IC-3_MeOH_20_40	5.587	1.602	1.387	1.274	8.078	12.937	49.971	50.029	2
3	16	Omeprazole_IC-3_EtOH_20_40	5.382	1.639	1.915	1.661	8.617	14.124	49.984	50.016	2
4	31	Omeprazole_OZ-3_EtOH_20_40	5.377	1.599	1.169	1.162	7.229	11.561	49.778	50.222	2
5	1	Omeprazole_AD-3_EtOH_20_40	3.996	1.509	1.257	1.404	8.779	13.25	50.054	49.946	2
6	8	Omeprazole_AY-3_MeOH_20_40	3.55	2.08	1.178	1.145	3.652	7.597	49.974	50.026	2
7	11	Omeprazole_IA-3_MeOH_20_40	3.428	1.523	1.464	1.312	7.435	11.327	49.973	50.027	2
8	4	Omeprazole_AS-3_EtOH_20_40	2.515	1.673	1.657	1.518	1.244	2.081	49.754	50.246	2
9	10	Omeprazole_IA-3_EtOH_20_40	1.586	1.157	1.322	1.279	7.115	8.234	49.347	50.653	2

Separation Parameters for Rank 1  
Column: CHIRALCEL® OZ-3/SFC  
Modifier: Methanol

Separation Parameters for Rank 2  
Column: CHIRALPAK® IC/SFC  
Modifier: Methanol

Separation Parameters for Rank 3  
Column: CHIRALPAK® IC/SFC  
Modifier: Ethanol

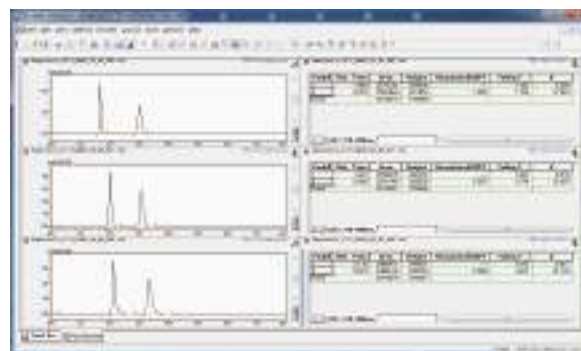

Fig. 4 Evaluation of Separation Parameters and Chiral Separation Chromatogram Using Optimized Parameters

\* CHIRALPAK® and CHIRALCEL® are registered trademarks of Daicel Corporation.

# Application News

## No. L517

### Supercritical Fluid Chromatography

## Analysis and Evaluation of Chiral Drugs in Biological Samples Using the Nexera UC-MS/MS System

As introduced in Application News No. L495, the optimization for chiral separation using supercritical fluid chromatography (SFC) starts from employing column scouting to find the column and mobile phase appropriate to separation. This article introduces an example of the selectivity and sensitivity of drug level monitoring in a biological sample and the evaluation results of the analysis method, as an application to the pharmacokinetics research of chiral separation using SFC/MS/MS, after having selected an appropriate column.

Y. Watabe, T. Hattori, T. Iida

### ■ Analysis of Omeprazole in a Plasma Sample

The applicability of human plasma matrix to SFC was evaluated taking an example of enantiomeric drug omeprazole, well-known as a proton pump inhibitor. Fig. 1 shows the chemical structure of omeprazole. Fig. 2 shows the pretreatment procedure employed for the blood plasma sample. Table 1 lists the analytical conditions. CHIRALPAK® IC-3 from Daicel Company, which exhibited good separation when utilized in Application News No. L495 was used as the column. Detection was performed using the LCMS-8050 triple quadrupole mass spectrometer.

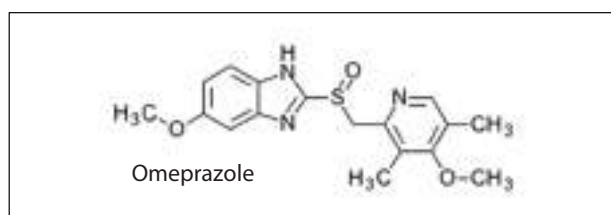

Fig. 1 Omeprazole Structure

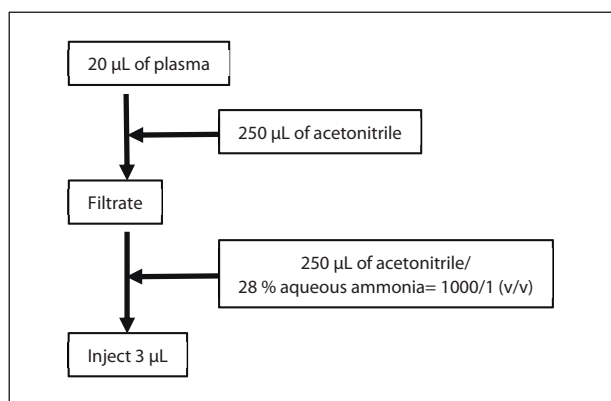

Fig. 2 Plasma Sample Pretreatment Procedure

Table 1 Analytical Conditions

Column	: CHIRALPAK®, IC-3 (100 mm L. × 3.0 mm I.D., 3 µm)
Mobile phase	: A) Super critical fluid of CO <sub>2</sub> B) Modifier: Methanol A/B = 5/1 (v/v for omeprazole, isocratic) = 4/1 (v/v for rabeprazole, isocratic)
Flow rate	: 3 mL/min
Column temp.	: 40 °C
Injection volume	: 3 µL
BPR pressure	: 10 MPa
BPR temp.	: 50 °C
Detector	: LCMS-8050 (ESI, MRM mode)
Make-up	: Methanol
Make-up flow rate	: 0.1 mL/min
MRM	: (+) <i>m/z</i> 346.1 > 198.1 (for omeprazole) (+) <i>m/z</i> 359.9 > 150.1 (for rabeprazole)

Calibration curve was created based on human plasma samples that contained 1, 2, 10, 2 and 100 µg/L of standard omeprazole to confirm the linearity of loaded amounts.

Fig. 3 and Fig. 4 show the MRM chromatograms for 2 µg/L and 20 µg/L respectively. Among the optically separated peaks, (A) is the fast-eluting isomer and (B) is the slow-eluting isomer. The linearity (*r*<sup>2</sup>) obtained after correcting by 1/(concentration squared) was favorable at 0.99996 for omeprazole (A) and 0.99998 for omeprazole (B).

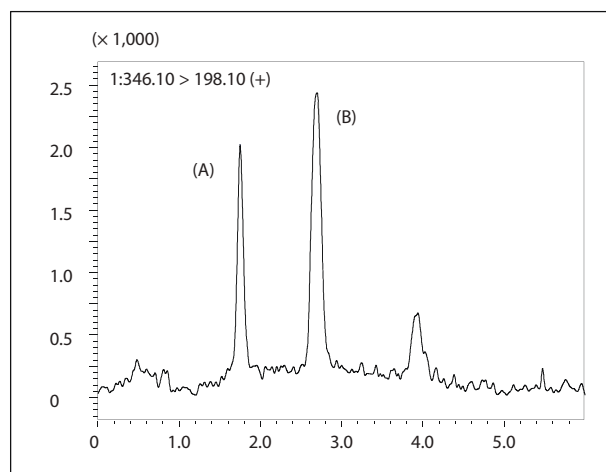

Fig. 3 Omeprazole Added to Human Plasma (2 µg/L)

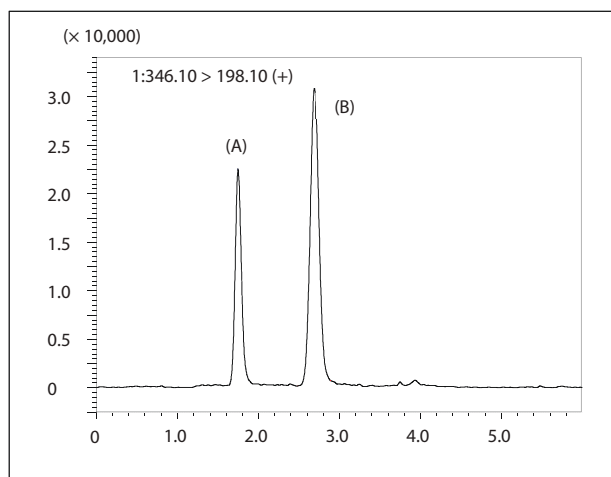

Fig. 4 Omeprazole Added to Human Plasma (20 µg/L)

The repeatability of the area values at 2 µg/L obtained from five repetitions was favorable with RSD values of 4.4 % for both omeprazole (A) and (B). At 10 µg/L, the recovery rates calculated from the results of stock solution analyses were 101.1 % and 100.5 % respectively.

#### ■ Analysis of Rabeprazole in a Plasma Sample

Rabeprazole, known as a gastric acid secretion inhibitor, has a similar chemical structure to omeprazole, suggesting the possibility of successful chiral separation under similar analytical conditions including the same analytical column. Here we attempted to analyze rabeprazole in a plasma sample based on the analytical conditions used for omeprazole in the previous section. The chemical structure of rabeprazole is shown below. The structural similarity to omeprazole is easily recognized. As shown in Table 1, analysis was successful by merely changing the modifier concentration and the MRM settings.

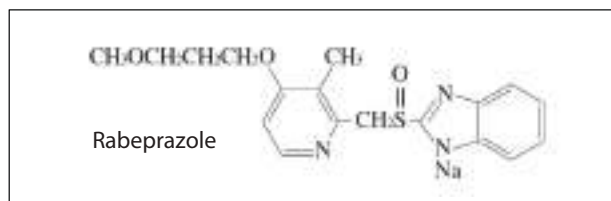

Fig. 5 Rabeprazole Structure

Calibration curve was crated based on human plasma samples that contained 0.3, 1, 3, 10 and 30 µg/L of standard raberlazole to confirm the linearity of loaded amounts. Fig. 6 and Fig. 7 show the MRM chromatograms for 3 µg/L and 30 µg/L respectively. As in Fig. 3 and Fig. 4, (A) is the fast-eluting isomer among the optically separated peaks and (B) is the slow-eluting isomer.

The linearity ( $r^2$ ) obtained after correcting by  $1/(\text{concentration squared})$  was favorable at 0.99996 for rabeprazole (A) and 0.99999 for rabeprazole (B).

Notes: This product has not been approved or certified as a medical device under the Pharmaceutical and Medical Device Act of Japan. It cannot be used for the purpose of medical examination and treatment or related procedures.

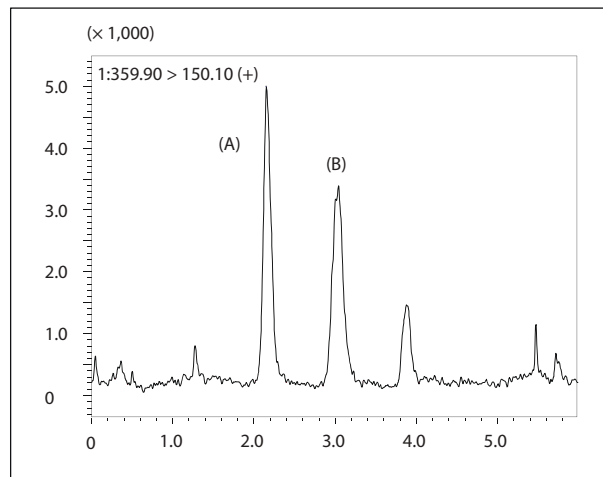

Fig. 6 Rabeprazole Added to Human Plasma (3 µg/L)

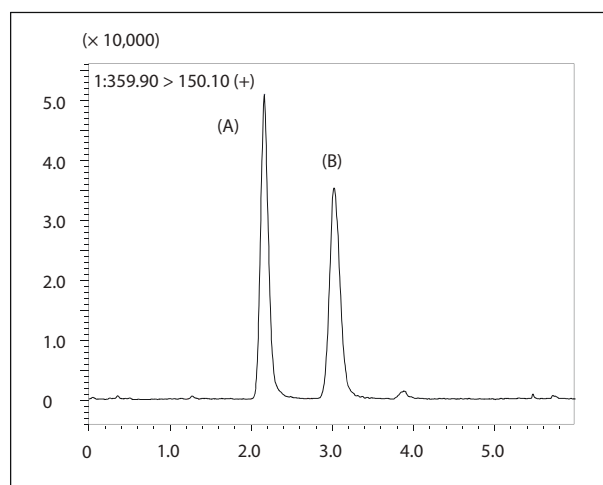

Fig. 7 Rabeprazole Added to Human Plasma (30 µg/L)

The repeatability of the area values at 10 µg/L obtained from five repetitions was favorable with RSD values of 1.8 % and 2.4 % for rabeprazole (A) and (B) respectively. The recovery rates calculated from the results of stock solution analyses were 102.5 % and 100.1 % respectively. Table 2 summarizes the linearity, peak area repeatability, and recovery rate for each compound. These results verify the applicability of this method to the practical analysis of plasma samples.

Table 2 Evaluation Results

	Linearity ( $r^2$ )	Area Repeatability (%RSD)	Recovery Rate (%) (4)
Omeprazole (A)	0.99996 (1)	4.4 (3)	101.1
Omeprazole (B)	0.99998 (1)	4.4 (3)	100.5
Rabeprazole (A)	0.99996 (2)	1.8 (4)	102.5
Rabeprazole (B)	0.99999 (2)	2.4 (4)	100.1

(1) 1 to 100 µg/L, (2) 0.3 to 300 µg/L, (3) 2 µg/L, (4) 10 µg/L

# Application News

## No. L519

### Supercritical Fluid Chromatography

## Analysis of Choline and Acetylcholine in Rat Cerebrospinal Fluid Samples Using the Nexera UC-MS/MS System

Choline, which is a structural element of cell membranes, and acetylcholine, which is known as a neurotransmitter, are both familiar compounds in the field of bioanalysis. Since acetylcholine is biosynthesized in the body from choline, it is possible to estimate the quality of internal activity by monitoring both of these compounds. This article focuses on the SFC analysis of these compounds in a rat cerebrospinal fluid sample by direct injection of the cerebrospinal fluid to the Nexera UC SFC system. Also introduced is automatic extraction and analysis of a cerebrospinal fluid sample impregnated into filter paper, in consideration of convenience and durability for storage and transport, using the Nexera UC online SFE-SFC-MS/MS system.

Y. Watabe, T. Iida

### SFC-MS/MS Analysis

A CN column provided favorable separation of choline and acetylcholine in SFC-MS/MS analysis. Calibration curves were created from the peak area values from six times repeated analyses for each of the three concentrations of 10, 100, and 1000 µg/L. Good linearity was obtained and the quantitation limit (LOQ, ASTM method) was 30 µg/L for choline and 10 µg/L for acetylcholine. Table 1 lists the conditions of SFC-MS/MS analysis. Fig. 1 shows the structural formula of choline and acetylcholine and Fig. 2 shows the obtained calibration curves.

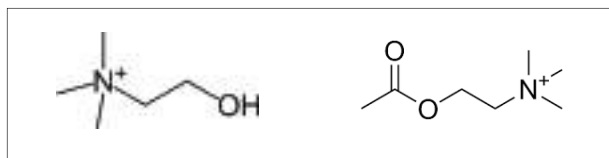

**Fig. 1 Structure of Choline (Left) and Acetylcholine (Right)**

**Table 1 SFC-MS/MS Analytical Conditions**

Column	: Inertsil CN-3 250 mm L. × 4.6 mm I.D., 5 µm
Mobile phase	: A) Supercritical fluid of CO <sub>2</sub> B) Modifier: Methanol containing 20 mmol/L ammonium formate / water =95/5 (v/v)
Time program	: B Conc. 10 % (0 min) → 25 % (10 min) → 50 % (10.1-12 min) → 10 % (12.1-15 min)
Flow rate	: 2.5 mL/min
Column temp.	: 40 °C
Injection volume	: 1 µL
BPR pressure	: 10 Mpa
BPR temp.	: 50 °C
Detector	: LCMS-8050 (ESI, MRM mode)
Make-up	: Methanol
Make-up flow rate	: 0.2 mL/min
MRM transitions	: (+) <i>m/z</i> 104.1 > 60.1 (for choline) (+) <i>m/z</i> 146.1 > 87.1 (for acetylcholine)

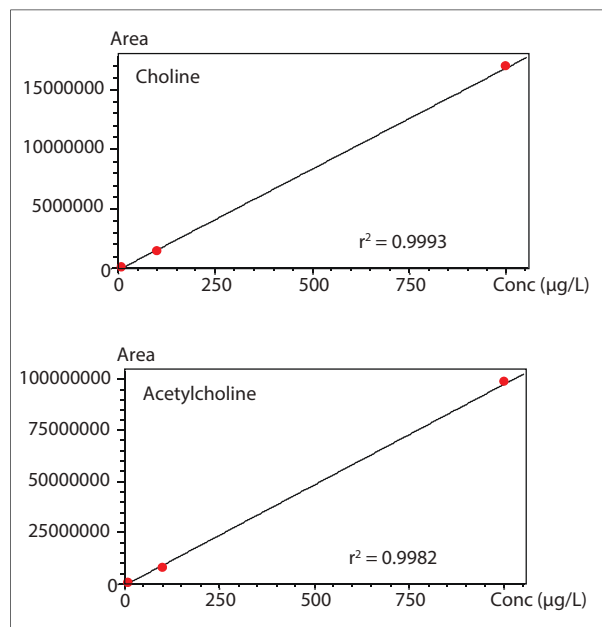
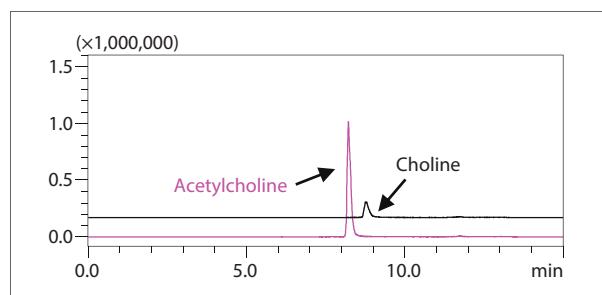

**Fig. 2 Calibration Curves of Choline and Acetylcholine**

The retention time and peak area repeatabilities after six repetitions at each concentration of 10, 100, and 1000 µg/L was confirmed at calibration curve creation and the results are summarized in Table 2. The linearity ( $r^2$ ) was 0.9993 for choline and 0.9982 for acetylcholine. Fig. 3 shows the MRM chromatograms for 100 µg/L.

**Table 2 Repeatabilities of Choline and Acetylcholine Standards (n = 6)**

		Retention time (%RSD)	Peak area (%RSD)
Choline	10 µg/L	0.22	7.5
Choline	100 µg/L	0.05	1.7
Choline	1000 µg/L	0.07	2.2
Acetylcholine	10 µg/L	0.07	5.7
Acetylcholine	100 µg/L	0.06	4.2
Acetylcholine	1000 µg/L	0.07	6.0



**Fig. 3 Choline and Acetylcholine Standards (100 µg/L)**



Next, by employing the microdialysis method in which biological compounds are continuously sampled from an awake animal via the semipermeable membrane of a minute dialytic probe connected to a pump, cerebrospinal fluid was sampled from a rat and directly delivered to SFC analysis. The injection volume of cerebrospinal fluid was set to 1  $\mu$ L due to concerns regarding the miscibility between the aqueous sample and low polar supercritical carbon dioxide, which is the main component of the mobile phase used in SFC. With respect to acetylcholine, the LOQ determined according to the ASTM method was about 10  $\mu$ g/L. Since the calculated concentration was less than the LOQ, only peak identification was performed. As shown in Table 3, the retention time and peak area repeatabilities were favorable for the six repeated analyses of choline. Fig. 4 shows the chromatograms resulting from SFC analysis of the cerebrospinal fluid sample.

**Table 3 Choline Quantitative Value in Rat Cerebrospinal Fluid Sample and Repeatabilities (n = 6)**

	Retention time (%RSD)	Peak area (%RSD)
Choline (Concentration 229.6 $\mu$ g/L)	0.10	3.1

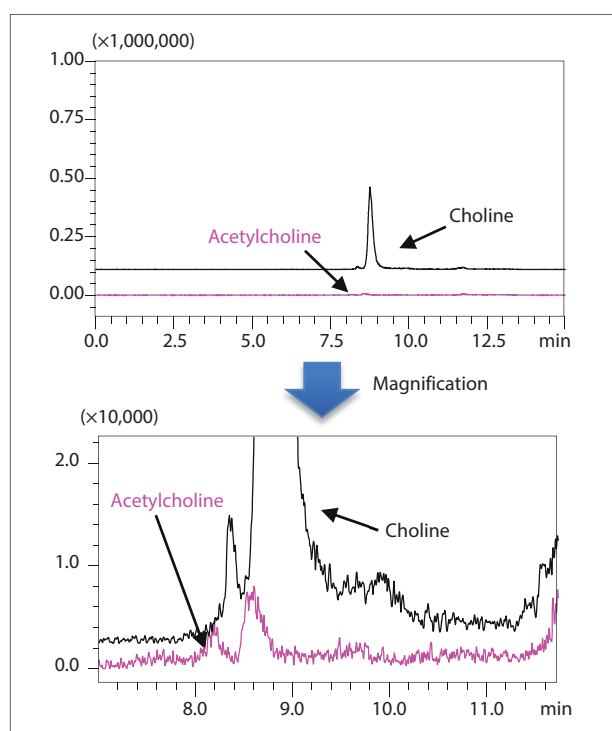

**Fig. 4 SFC Analysis of Choline and Acetylcholine in a Cerebrospinal Fluid Sample**

### ■ Online SFE-SFC-MS/MS Analysis

Next, a sample was prepared by impregnating cerebrospinal fluid sample into filter paper and drying the paper. SFE-SFC-MS/MS analysis was then performed on the sample. The convenience of this method is gaining attention not only because of easy of sample handling but also because of improved miscibility concerns between a mobile phase of low polar supercritical carbon dioxide and an aqueous sample solvent containing a biological sample. Table 4 lists the conditions used in online SFE-SFC-MS/MS analysis.

**Table 4 Online SFE-SFC-MS/MS Conditions**

Vessel	: 0.2 mL (1 $\mu$ L of sample was added to filter paper)
Extractant	: A) Supercritical fluid of CO <sub>2</sub> B) Methanol containing 20 mmol/L ammonium formate / water = 95/5 (v/v) A/B = 9/1 (v/v)
Flow rate	: 2.5 mL/min
Extraction time	: Static (0-3 min) – Dynamic (3-6 min) – Static (6-8 min) - Dynamic (8-11 min) – Static (11-13 min) – Dynamic (13-16 min)
BPR pressure	: 10 Mpa
Extraction temp.	: 60 °C
Time program	: B Conc. 10 % (16 min) → 25 % (26 min) → 50 % (26.1-28 min) → 10 % (28.1-31 min)

\* SFC-MS/MS conditions are identical to Table 1 except for the time program.

Fig. 5 shows the result obtained from online SFE-SFC-MS/MS analysis of a sample created by dropping 1  $\mu$ L of 100  $\mu$ g/L standard solution onto filter paper (GA-200 by ADVANTEC). Fig. 6 shows the result obtained by processing the rat cerebrospinal fluid sample in the same manner. The peak obtained for acetylcholine was small like the SFC analysis result, however, since the baseline noise level was improved in comparison, improved LOQ was obtained. Because the S/N value of corresponding peak to acetylcholine was more than 15 based on the baseline noise determined by ASTM method, a simple quantitative calculation was made based on the 100  $\mu$ g/L standard data in the same way as the more concentrated choline. The obtained choline concentration of 297  $\mu$ g/L was close to the SFC result and suggested that extraction in online SFE was performed efficiently. For acetylcholine, a calculation result of 1.7  $\mu$ g/L was obtained from the peak area.

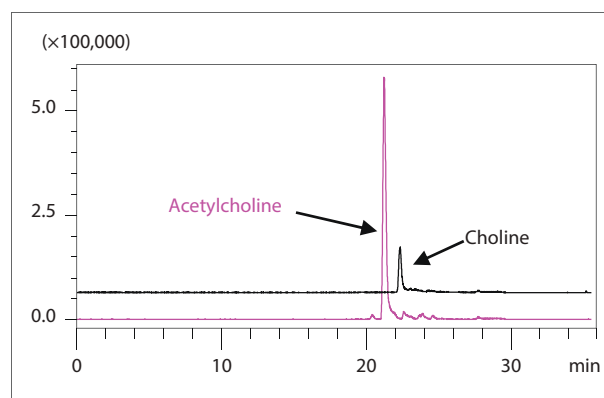

**Fig. 5 Online SFE-SFC Analysis of Choline and Acetylcholine Standards**

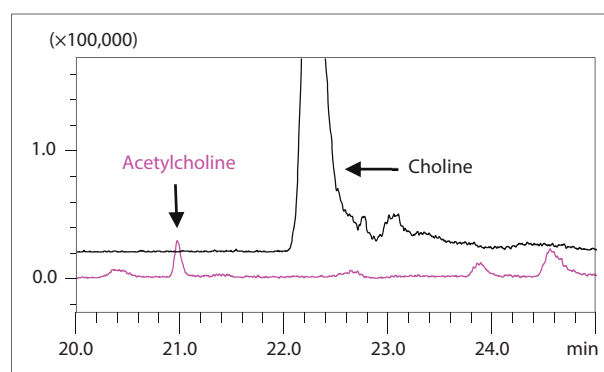

**Fig. 6 Online SFE-SFC Analysis of Choline and Acetylcholine in a Cerebrospinal Fluid Sample**

First Edition: Mar. 2017



For Research Use Only. Not for use in diagnostic procedure.

This publication may contain references to products that are not available in your country. Please contact us to check the availability of these products in your country.

The content of this publication shall not be reproduced, altered or sold for any commercial purpose without the written approval of Shimadzu. Company names, product/service names and logos used in this publication are trademarks and trade names of Shimadzu Corporation or its affiliates, whether or not they are used with trademark symbol "TM" or "®". Third-party trademarks and trade names may be used in this publication to refer to either the entities or their products/services. Shimadzu disclaims any proprietary interest in trademarks and trade names other than its own.

The information contained herein is provided to you "as is" without warranty of any kind including without limitation warranties as to its accuracy or completeness. Shimadzu does not assume any responsibility or liability for any damage, whether direct or indirect, relating to the use of this publication. This publication is based upon the information available to Shimadzu on or before the date of publication, and subject to change without notice.

Shimadzu Corporation

www.shimadzu.com/an/

# Application News

## No. C149

### Liquid Chromatograph Mass Spectrometry

## Developing a Chiral Amino Acid Analysis Method That Uses Column Switching

With the exception of glycine, the 20 types of amino acids that make up proteins occur as D and L optical isomers. L-amino acids occur in large quantities in the body as protein components and sources of nutrients. As for D-amino acids, despite the fact that they are much less abundant than L-amino acids, they are attracting attention in various fields as components associated with the component analysis of fermented foods, physiological functions in the central nervous system, biomarkers, and even health and beauty.

Analysis of D-amino acids is susceptible to interference by a wide variety of peptides and amino compounds, and therefore requires high sensitivity and highly selective

analysis methods for accurate measurement. Furthermore, conventional optical separation analysis of amino acids necessitated derivatization and long separation times of the amino acids.

This article introduces a rapid analysis method that employs chiral columns to achieve high separation and high sensitivity and that dispenses with derivatization [1]. This system uses two types of chiral columns alternately with high-pressure column switching valves (FCV) and allows fully automatic analysis of a wide range of D- and L-amino acids.

Y. Uno, T. Hattori

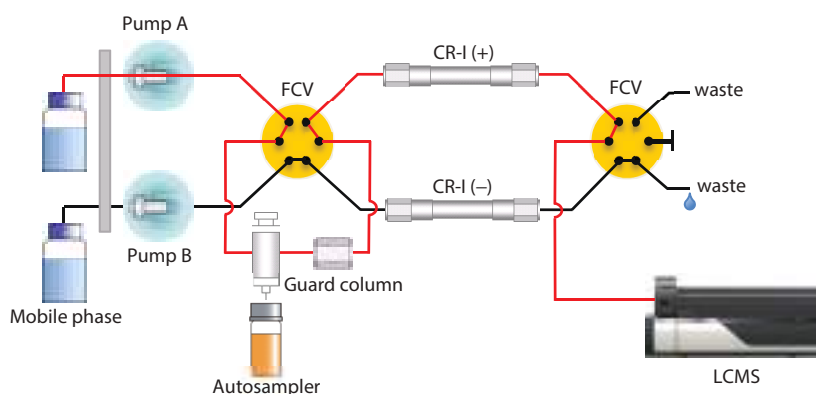

**Fig. 1 Chiral Amino Acid Analysis System That Uses Column Switching**

A system capable of analysis by automatically switching between two column types, CR-I (+) and CR-I (-), using two high-pressure column switching valves (FCV) was configured (Fig. 1). Pump A is connected to CR-I (+) and pump B is connected to CR-I (-). This means that even if one column is undergoing analysis, the other column can undergo stabilization without stopping mobile phase delivery.

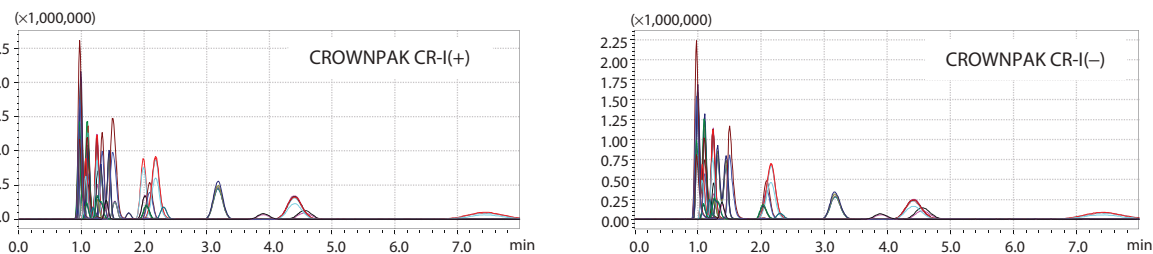

**Fig. 2 MRM Chromatograms of D- and L-Amino Acids in Standard Mixed Solution (Sample Concentration: 1 ng/1 μL)**

**Table 1 Analysis Conditions**

Column	: CROWNPAK CR-I (+) / CR-I (-) (3 mm × 150 mm, 5 μm, DAICEL Corp.)
Mobile phase	: Acetonitrile/ethanol/water/TFA = 80/15/5/0.5
Flow rate	: 0.6 mL/min
Injection volume	: 1 μL
Oven temperature	: 20 °C
Ionization mode	: ESI (Positive)
Probe voltage	: +4.0 kV
Neburizing gas flow	: 3.0 L/min
Drying gas flow	: 15.0 L/min
Heating gas flow	: 5.0 L/min
Interface temperature	: 250 °C
DL temperature	: 250 °C
Block heater temperature	: 300 °C

### ■ Analysis of Standard Solution

This system was employed to analyze a standard mixed solution using <sup>13</sup>C<sub>6</sub>-L-Phe as the internal standard (Fig. 2). Approximately equal area ratios were obtained with CR-I (+) and CR-I (-) for the amino acids other than Gln, Lys, Ile, *allo*-Ile, Thr, and *allo*-Thr, and this confirmed that the system is capable of separation measurement (Table 2).

With CR-I (+), L-Gln and D-Lys, D-Ile and D-*allo*-Ile, and D-Thr and D-*allo*-Thr, which each have the same MRM transition, are detected with the same peak and therefore cannot be separated.

With CR-I (-), D-Gln and L-Lys, L-Ile and L-*allo*-Ile, and L-Thr and L-*allo*-Thr, which each have the same MRM transition, are detected with the same peak and therefore cannot be separated.

However, separation measurement can be performed for these amino acids by utilizing two types of columns. For example, while D-Thr and D-*allo*-Thr cannot be separated with CR-I (+) and L-Thr and L-*allo*-Thr cannot be separated with CR-I (-), interchanging the column types allows for separation measurement (Fig. 3).

**Table 2 Analysis Results of Standard Solution**

	CR-I (+)		CR-I (-)		Ratio of Area (+)/(-)		CR-I (+)		CR-I (-)		Ratio of Area (+)/(-)
	RT	Ratio of Area	RT	Ratio of Area			RT	Ratio of Area	RT	Ratio of Area	
D-Ala	1.394	0.728	3.894	0.751	0.97	D-Leu	1.107	2.019	3.178	2.400	0.84
L-Ala	3.908	0.565	1.389	0.632	0.89	L-Leu	3.179	2.929	1.105	3.364	0.87
D-Arg	0.973	3.999	1.506	3.239	1.23	D-Lys	2.181	4.621 with L-Gln	7.395	1.641	2.82
L-Arg	1.499	5.633	0.981	6.718	0.84	L-Lys	7.348	1.795	2.161	5.118 with D-Gln	0.35
D-Asn	1.255	1.018	2.036	1.030	0.99	D-Met	1.259	1.704	4.554	1.859	0.92
L-Asn	2.036	0.805	1.263	0.911	0.88	L-Met	4.556	0.938	1.25	1.060	0.89
D-Asp	1.253	0.742	2.039	0.863	0.86	D-Phe	1.101	1.568	2.087	1.974	0.79
L-Asp	2.036	0.72	1.259	0.775	0.93	L-Phe	2.089	2.175	1.106	2.280	0.95
D-Cys	1.183	0.405	2.307	0.458	0.89	DL-Pro	0.957	2.756	0.971	3.105	0.89
L-Cys	2.308	0.789	1.186	0.797	0.99	D-Ser	1.222	0.224	1.756	0.253	0.89
D-Gln	1.247	2.111	2.161	3.478 with L-Lys	0.61	L-Ser	1.758	0.307	1.226	0.301	1.02
L-Gln	2.183	4.947 with D-Lys	1.239	3.686	1.34	D-Thr	1.023	1.339 with D- <i>allo</i> -Thr	1.53	0.968	1.38
D-Glu	1.246	2.972	4.426	3.262	0.91	L-Thr	1.533	0.851	1.033	1.324 with L- <i>allo</i> -Thr	0.64
L-Glu	4.388	3.506	1.24	3.731	0.94	D- <i>allo</i> -Thr	1.023	1.339 with D-Thr	1.205	0.573	2.34
Gly	2.827	0.037	2.796	0.039	0.93	L- <i>allo</i> -Thr	1.197	0.480	1.033	1.397 with L-Thr	0.34
D-His	0.967	2.797	1.099	3.917	0.71	D-Trp	1.105	2.839	1.99	3.344	0.85
L-His	1.09	3.699	0.977	2.969	1.25	L-Trp	1.988	3.458	1.111	3.510	0.99
D-Ile	0.988	4.745 with D- <i>allo</i> -Ile	1.446	2.983	1.59	D-Tyr	1.103	1.203	2.016	1.560	0.77
L-Ile	1.44	2.325	0.998	4.408 with L- <i>allo</i> -Ile	0.53	L-Tyr	2.016	1.448	1.109	1.455	1.00
D- <i>allo</i> -Ile	0.988	4.745 with D-Ile	1.313	2.926	1.62	D-Val	0.999	1.826	1.337	2.052	0.89
L- <i>allo</i> -Ile	1.308	1.844	0.998	4.101 with L-Ile	0.45	L-Val	1.331	3.170	1.008	3.251	0.97

indicates amino acids that can be separated by one column but not the other.

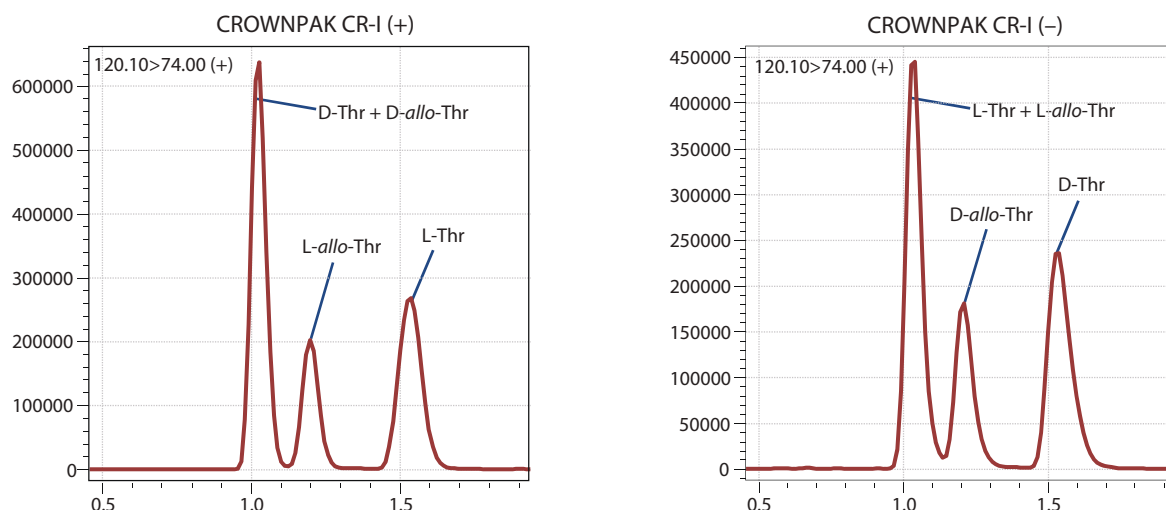

**Fig. 3 Analysis Result of D/L-Threonine and D/L-*allo*-Threonine**

References [1] Nakano, Y., Konya, Y., Taniguchi, M., Fukusaki, E., *Journal of Bioscience and Bioengineering*, 123, 134-138 (2016)

The analysis method presented in this edition of Application News was developed by the Fukusaki Lab in the School/Graduate School of Engineering at Osaka University.

First Edition: Apr. 2017



For Research Use Only. Not for use in diagnostic procedure.

This publication may contain references to products that are not available in your country. Please contact us to check the availability of these products in your country.

The content of this publication shall not be reproduced, altered or sold for any commercial purpose without the written approval of Shimadzu. Company names, product/service names and logos used in this publication are trademarks and trade names of Shimadzu Corporation or its affiliates, whether or not they are used with trademark symbol "TM" or "®". Third-party trademarks and trade names may be used in this publication to refer to either the entities or their products/services. Shimadzu disclaims any proprietary interest in trademarks and trade names other than its own.

The information contained herein is provided to you "as is" without warranty of any kind including without limitation warranties as to its accuracy or completeness. Shimadzu does not assume any responsibility or liability for any damage, whether direct or indirect, relating to the use of this publication. This publication is based upon the information available to Shimadzu on or before the date of publication, and subject to change without notice.

Shimadzu Corporation

www.shimadzu.com/an/

# Upgrade Your Existing UHPLC to an UHPLC/SFC Switching System

## Reduce Instrument Purchase Costs and Enable SFC Analysis Immediately

You can now upgrade to an UHPLC/SFC switching system (Nexera UC/s) by adding the applicable SFC units to your existing UHPLC system.

This enables you to perform both UHPLC and SFC analysis with a single system.

Upgrading Lowers  
Purchasing Costs and  
Reduces Installation Space



UHPLC System



UHPLC/SFC Switching System (Nexera UC/s)

## SFC Analysis Improves Separation and Analysis Times, while Reducing Solvent Consumption

In comparison to UHPLC, column efficiency is not impaired in SFC analysis even at a high flow rate. As a result, analysis times are shortened by the increase in speed. At the same time, since the separation characteristics are different, improved separation can be expected for foreign substances and isomers that are not sufficiently separated by UHPLC. Further, the consumed amount of organic solvents can be reduced.

### Improved Separation with SFC Analysis

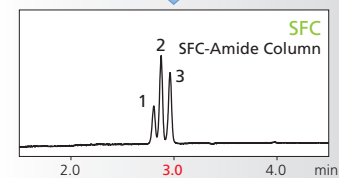
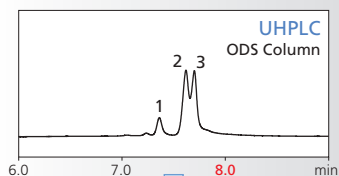

### Shortened Analysis Times

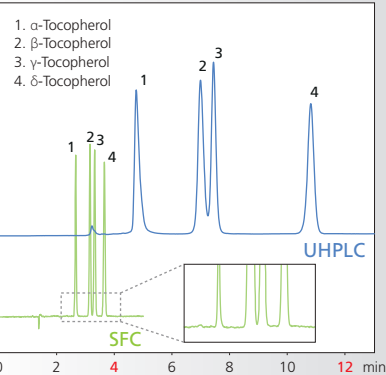

### Reduced Solvent Consumption

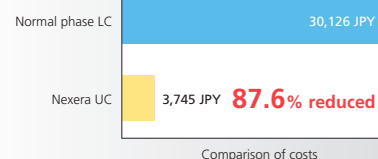
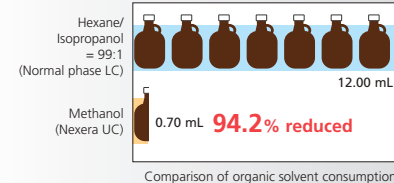

## Reliable Analysis Even When Switching Between SFC and UHPLC Modes

SFC and UHPLC utilize significantly different mobile phases and separation characteristics, but analysis can be performed reliably without effects from switching modes by simply purging the flow lines.

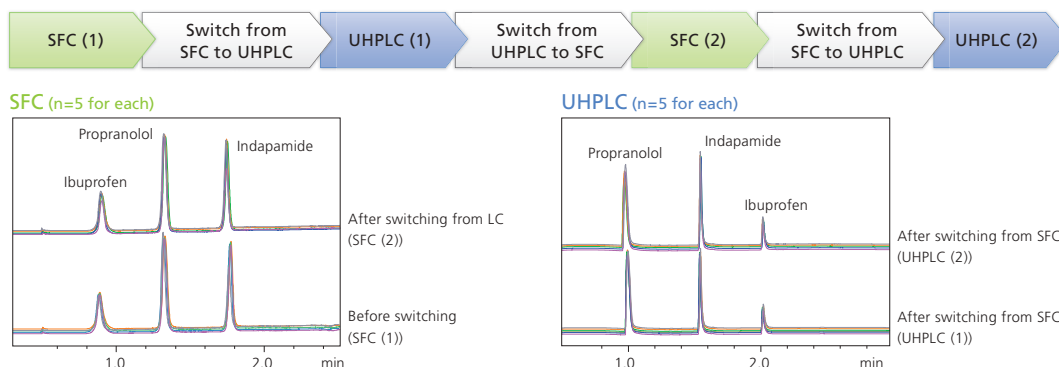

## Two Separation Methods Heighten the Efficiency of Examining the Optimal Separation Conditions

Various separation methods, including the separation of chiral compounds and structural isomer, are required in fields such as pharmaceuticals, foods, and the environment. For example, in the case of method scouting with two chiral standard samples, favorable separation is obtained for omeprazole with UHPLC conditions, and indapamide with SFC conditions. Screening utilizing these two methods makes it possible to construct better analysis conditions in a short time. Switching between SFC and UHPLC analysis methods is easy with the dedicated software.

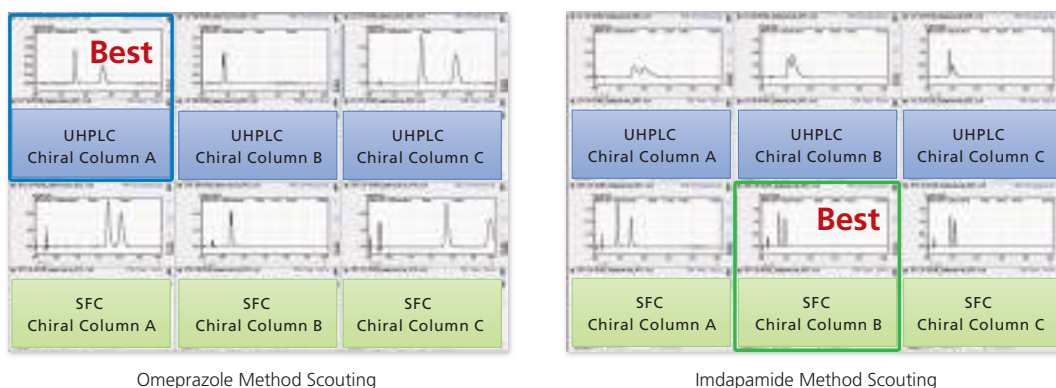

Omeprazole Method Scouting

Indapamide Method Scouting

## Kit for Upgrading to an SFC Analysis System

You can upgrade to an UHPLC/SFC switching system (Nexera UC/s) capable of UHPLC and SFC analysis using the existing\* solvent delivery unit, autosampler, oven, and detectors.

\* The following units can be used in combination when upgrading.

- Solvent delivery Unit: LC-30AD
- Autosampler: SIL-30AC
- Column oven: CTO-20A/20AC
- Detector: SPD-20A(V), SPD-M20A
- Mass spectrometer: LCMS-2020, LCMS-80X0

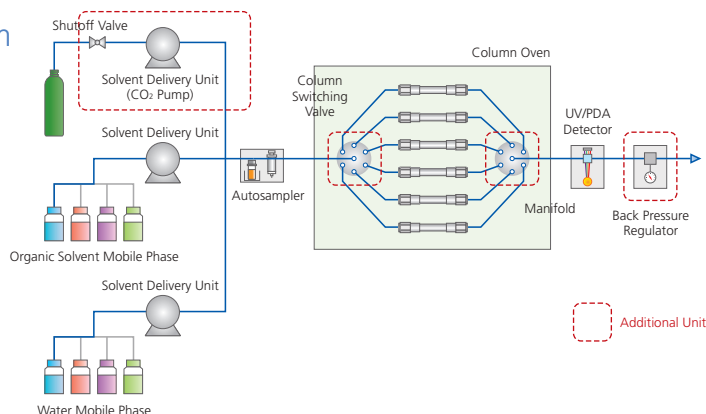

**For Research Use Only. Not for use in diagnostic procedures.**

This publication may contain references to products that are not available in your country. Please contact us to check the availability of these products in your country.

Company names, products/service names and logos used in this publication are trademarks and trade names of Shimadzu Corporation, its subsidiaries or its affiliates, whether or not they are used with trademark symbol "TM" or "®".

Third-party trademarks and trade names may be used in this publication to refer to either the entities or their products/services, whether or not they are used with trademark symbol "TM" or "®". Shimadzu disclaims any proprietary interest in trademarks and trade names other than its own.

The contents of this publication are provided to you "as is" without warranty of any kind, and are subject to change without notice. Shimadzu does not assume any responsibility or liability for any damage, whether direct or indirect, relating to the use of this publication.

Shimadzu Corporation  
www.shimadzu.com/an/

# Application News

## No. T152

### Thermal Analysis

## Polymorphism of Drugs

### ■ Introduction

Polymorphism is the phenomenon of materials with the same chemical structure having different crystalline structures. The different crystal forms of polymorphic materials have different properties, including solubility and stability, so evaluating polymorphism is an important part of drug development. Differential scanning calorimetry (DSC) is an effective technique for investigating polymorphism that requires no sample pretreatment and performs measurements quickly. DSC can be used to evaluate polymorphism based on different crystal shapes having different melting points and heat of fusions. Here, we describe an example use of DSC to analyze polymorphs.

### ■ Measurement of Carbamazepine

Carbamazepine is used as an anticonvulsant and is known to exist in multiple crystal forms. Carbamazepine form I (Fig. 1) and form III (Fig. 2) were analyzed. A sharp endothermic peak can be observed with both forms at around 190 °C. This peak represents the melting of crystal form III. An endothermic/exothermic peak is visible between 170 °C and 180 °C with crystal form I. This phenomenon is speculated to be caused by recrystallization of form I to stable form III following melting.

### ■ Measurement of Sulfapyridine

Sulfapyridine was heated to 205 °C (first run), then cooled and heated again (second run) (Fig. 3). During the first run, only the melting peak of a stabilized phase is visible at 192.2 °C, while during the second run, there is a glass transition at 54.7 °C, a crystallization peak at 101 °C, and the melting peak of a quasi-stable phase at 181.9 °C.

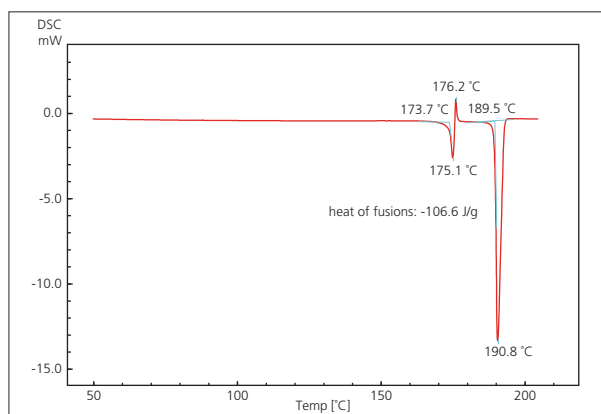

Fig. 1 DSC Measurement of Carbamazepine Form I

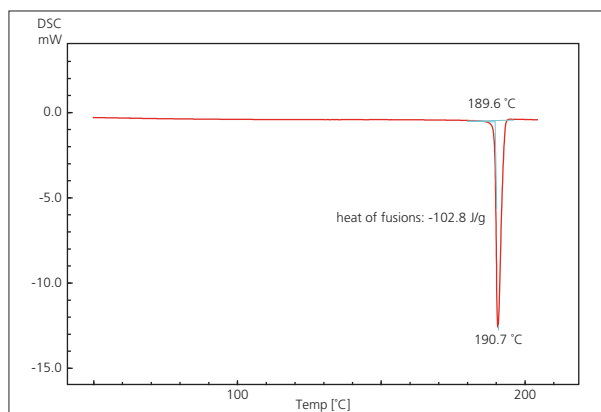

Fig. 2 DSC Measurement of Carbamazepine Form III

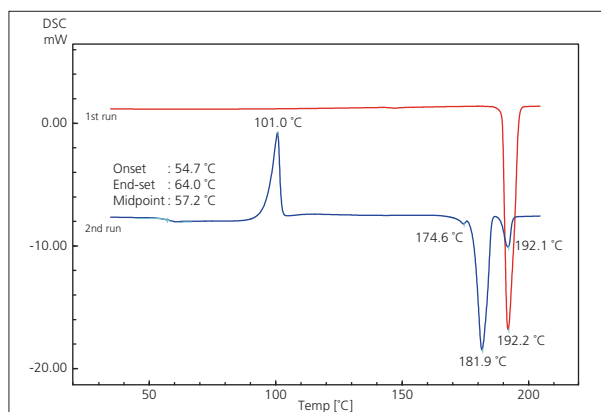

Fig. 3 DSC Measurement of Sulfapyridine

### ■ Measurement of Tripalmitin

Tripalmitin is also known to be polymorphic. In Fig. 4, the melting peak seen at 61.6 °C during the first run corresponds to melting of stable crystal form  $\beta$ .

Next, an exothermic peak at 42.5 °C is seen during the cooling process. This peak equates to crystallization of quasi-stable crystal form  $\alpha$ . The exothermic/ endothermic peak observed in the region of 45 °C to 58 °C during the second run equates to melting of form  $\alpha$  followed by crystallization of form  $\beta$ . The heat of fusion of form  $\beta$  melting at around 60 °C is observed to be smaller due to incomplete crystallization of form  $\beta$ .

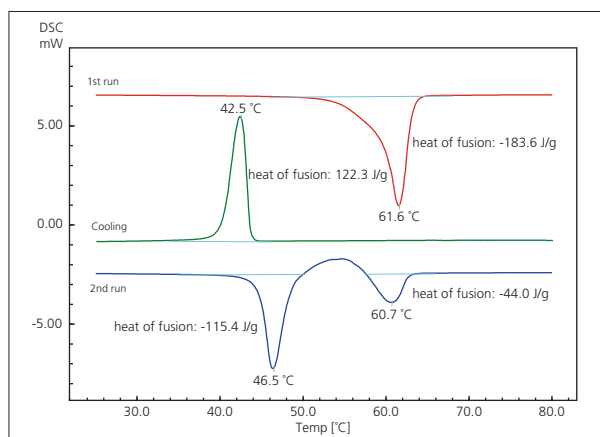

Fig. 4 DSC Measurement of Tripalmitin

### ■ Measurement of a Suppository

Fig. 5 shows data from heating (first run), cooling, and reheating (second run) of a commercially available suppository drug. The melting peak shapes are different during the first run and second run. This difference is due to a change in the crystal form of triglyceride present in the suppository drug caused by the heating method used. Because different crystal forms give rise to different melting characteristics and cracking behaviors, optimum heat treatment conditions must be investigated.

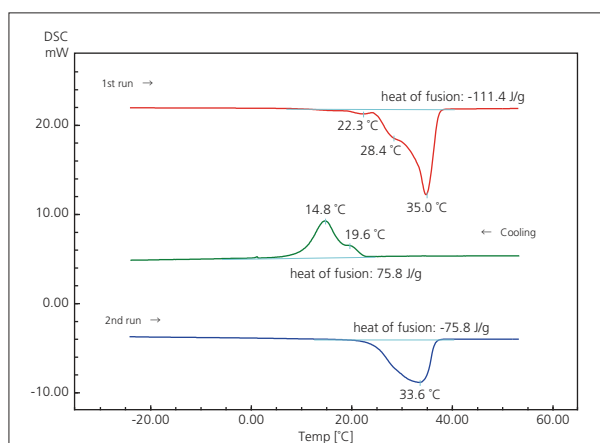

Fig. 5 DSC Measurement of a Suppository

### ■ Measurement of Sulfathiazole

Fig. 6 shows the results of analyzing sulfathiazole. The peak at 169.8 °C is presumed to represent the transition from a quasi-stable phase to a stable phase, and the peak at 201.1 °C is presumed to be melting of the stable phase.

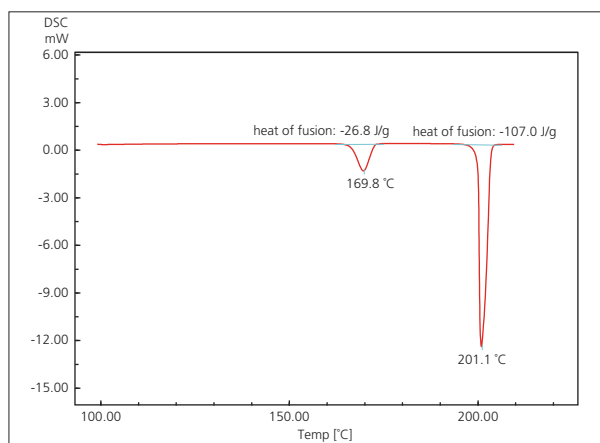

Fig. 6 DSC Measurement of Sulfathiazole

# Application News

## No. L499A

Supercritical Fluid Extraction / Chromatography

### Application of Online SFE-SFC-PDA for Cleaning Validation

Cleaning validation is a process step that is extremely important for ensuring high quality and safety at pharmaceutical manufacturing sites. Cloth used for surface wiping, called a swab, is used to wipe a given part of a piece of manufacturing equipment, and analysis of the wiped area of the swab is performed by using high-performance liquid chromatography (HPLC) or a total organic carbon analysis (TOC). Evaluations using HPLC have been increasingly used in recent years because HPLC enables determination of individual compounds. Prior to analysis, an extraction procedure must be performed on the swab. Using supercritical fluid extraction (SFE) as the pretreatment method allows for simple and quick target component extraction. Using supercritical fluid chromatography (SFC) after SFE also means that analysis results can be obtained simply by preparing the sample for SFE, which unifies the work flow from pretreatment to analysis. Please see Application News L496 for an overview of online SFE-SFC. This article describes the process of column selection using the Nexera-UC Chiral Screening System as the first step in analysis of the target compound alkylbenzenesulfonate.

#### ■ Analytical Column Selection

For SFC analysis, selection of the optimal column for the sample has a substantial effect on analysis reliability. We performed SFC separation of alkylbenzenesulfonate in four different columns under the conditions shown in Table 1 and Fig. 1, and chose the Shim-pack UCX-SIL analytical column as it had the best peak shape. Based on an investigation of gradient profiles, we also found a relatively steep gradient profile is suitable for quantitative analysis as the properties of alkylbenzenesulfonate, which have different length of carbon chains, mean the significant peak broadening if the gradient slope is not steep. Based on this information, we optimized analytical conditions using the Shim-pack USX-SIL column and performed online SFE-SFC analysis of a sample from a swab.

Table 1 SFC Analytical Conditions for Column Selection

Column	: Shim-pack UCX series columns (250 mm L. x 4.6 mm I.D., 5 μm) (i) UCX-RP (ODS with polar group), (ii) UCX-GIS (ODS), (iii) UCX-SIL, (iv) UCX-DIOL
Mobile Phase	: A: CO <sub>2</sub> ; B: Methanol
Time Program	: Shown in the figure
Flowrate	: 3.0 mL/min
Column Temp.	: 40 °C
Back Pressure	: 15 MPa
Wavelength	: 220 nm
Injection Vol.	: Shown in figure

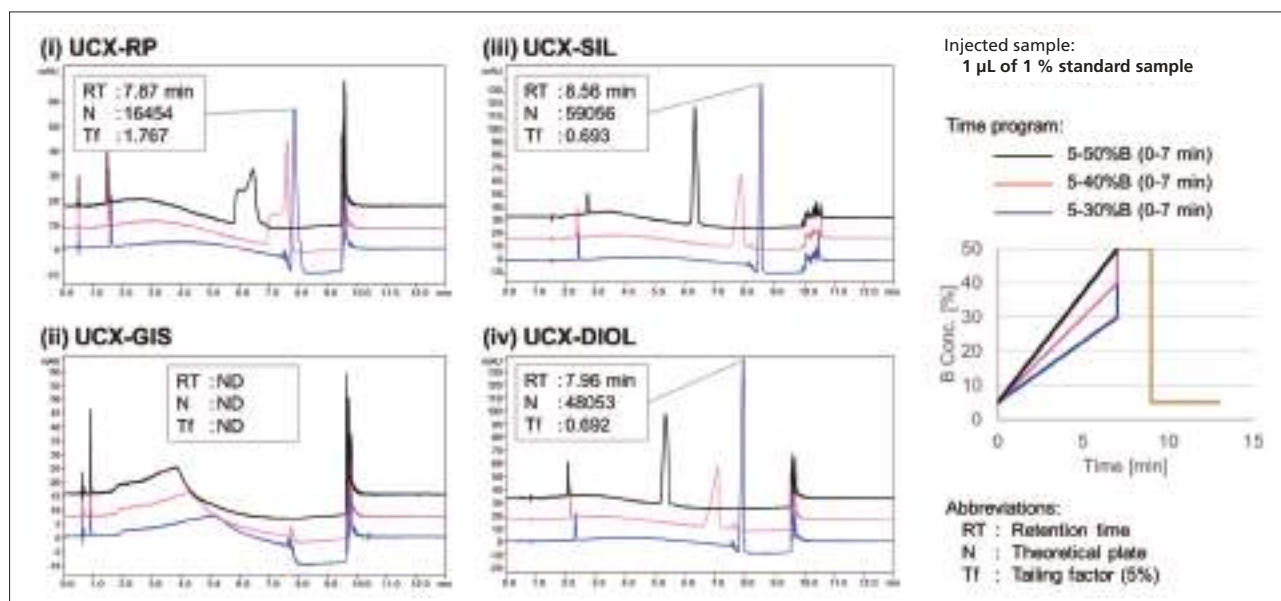

Fig. 1 Comparison of SFC Separation of Standard Alkylbenzenesulfonate in Four Different Columns



### ■ Online SFE-SFC Analysis of a Swab Containing Alkylbenzenesulfonate

We investigated column selection by the scouting system, chose the Shim-pack UCX-SIL analytical column, optimized each analytical condition for online SFE-SFC analysis, then performed analysis using the conditions shown in Table 2 below.

**Table 2 Analytical Conditions for Online SFE-SFC**

<b>[Sample Preparation]</b>	
A total of 10 to 500 µg standard samples in methanol were dropped onto swabs.	
The swabs were enclosed into an extraction vessel and set to the SFE unit.	
<b>[Static Extraction]</b>	
Extraction Time: 3 min	
Mobile Phase	: A: CO <sub>2</sub> ; B: 0.1 % (w/v) Ammonium Formate in Methanol
B Conc.	: 10 %
Flowrate	: 3.0 mL/min
Back Pressure	: 15 MPa
<b>[Dynamic Extraction]</b>	
Extraction Time: 3 min	
Mobile Phase	: A: CO <sub>2</sub> ; B: Methanol
B Conc.	: 10 %
Flowrate	: 3.0 mL/min
Back Pressure	: 15 MPa
<b>[SFC]</b>	
Column	: Shim-pack UCX-SIL (250 mm L. × 4.6 mm I.D., 5 µm)
Mobile Phase	: A: CO <sub>2</sub> ; B: Methanol
Time Program	: 10 %B (0-2 min), 10-60 %B (2-7 min), 60 %B (7-9 min), 10 %B (9-13 min)
Flowrate	: 3.0 mL/min
Column Temp.	: 40 °C
Back Pressure	: 15 MPa
Wavelength	: 220 nm

The peak for the surfactant alkylbenzenesulfonate was well-separated and detected as shown in Fig. 2 below. Fig. 3 shows the results of performing repeated SFE-SFC analyses from the same swab to which had been added an equivalent of 100 ng of alkylbenzenesulfonate. Since there was almost no alkylbenzenesulfonate peak evident from the second and later sample extractions, the extraction procedure was almost entirely complete after the first SFE. Fig. 4 shows the results of adding amounts of alkylbenzenesulfonate to swabs in the range of 10 to 500 µg, and checking linearity. Within this range, the coefficient of determination that represents linearity was 0.996. Fig. 5 shows the result of five consecutive analyses of separate swabs to which were added 100 µg of alkylbenzenesulfonate. Considering the process including extraction, the repeatability of retention times was 0.19 %RSD, and repeatability of peak area was 5.76 %RSD. Based on these results, we confirmed the usefulness of the Nexera-US Online SFE-SFC System in this application.

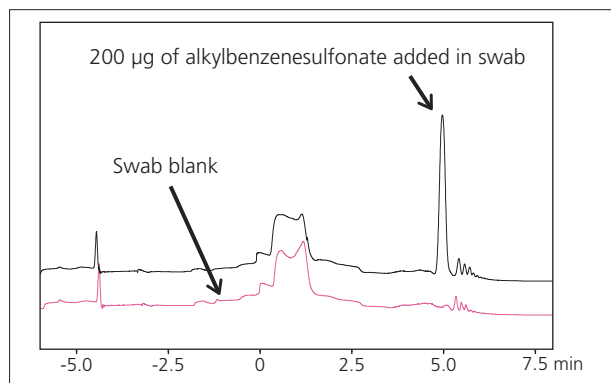

**Fig. 2 Online SFE-SFC Analysis of Alkylbenzenesulfonate**

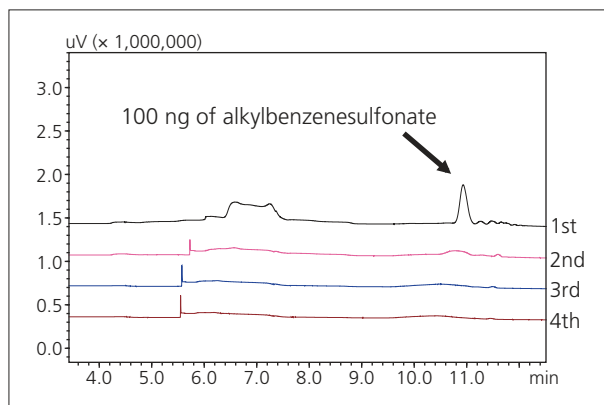

**Fig. 3 Confirmation of Online SFE Extraction Efficiency**

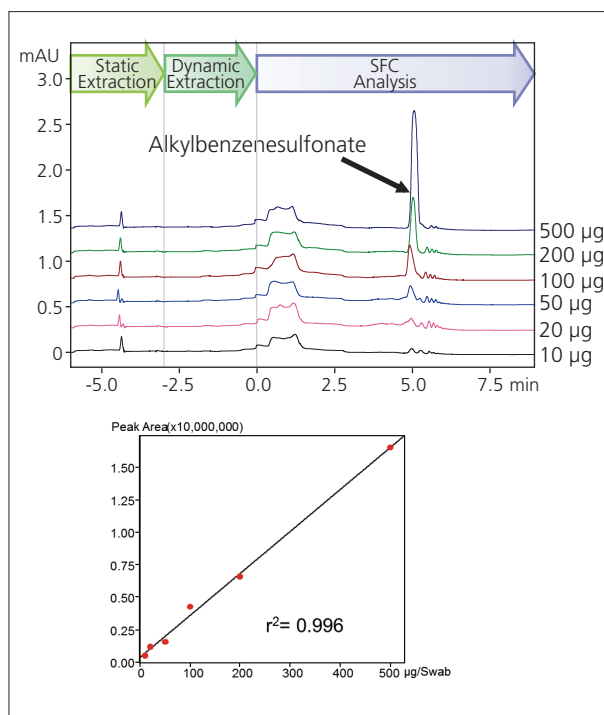

**Fig. 4 Linearity of Online SFE-SFC Analysis Using a Swab**

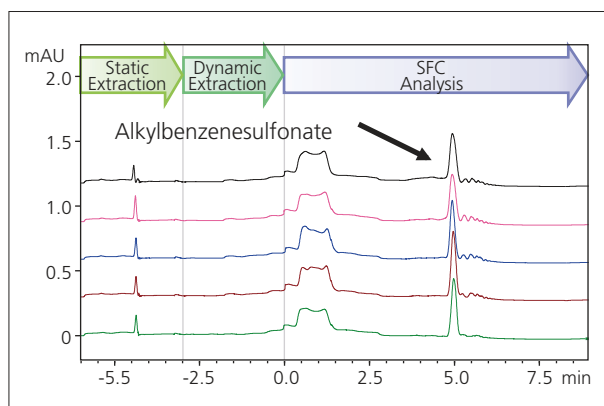

**Fig. 5 Repeatability of Online SFE-SFC Analysis Using a Swab**

Note: Swab samples were provided by DAICHI SANKYO COMPANY, LIMITED.

Second Edition: Feb. 2016  
First Edition: Jan. 2016



## LabSolutions LCMS Measurement Result Judgment Assistance Software iFlagger

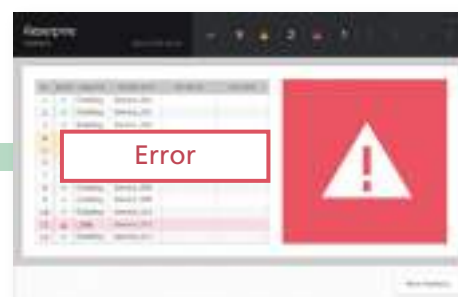
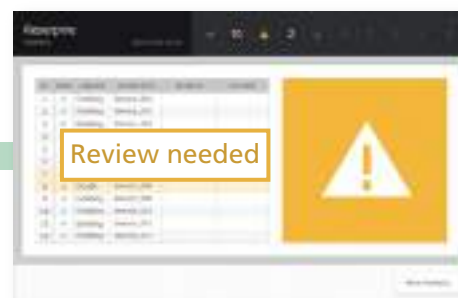
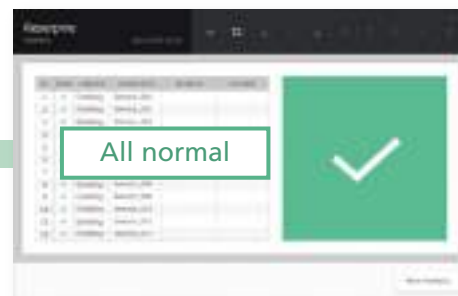
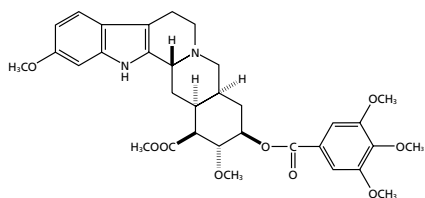

### Seamlessly Assists in Data Processing and Reporting

iFlagger for the LCMS-2020 ultra fast liquid chromatograph mass spectrometer uses parameters to assist in determining the presence of a target compound. By selecting the target compound and selecting user-friendly options and prompts in iFlagger, analyzing and reporting data can be performed automatically.

To ensure that the entire results for a batch analysis can be understood at a glance, the results are displayed with large images.

### Question

The process of judging whether a particular component is present is time consuming. Is there a more convenient method?

### Solution

Yes! With iFlagger, by presetting parameters such as ion intensity ratios and degree of similarity to a mass spectral library, the data results can be classified automatically, as normal, review needed, or error. These parameters can be set for each individual compound and allows the reviewer to view just the data that needs attention.

### Question

LCMS data can be difficult to review, especially without formal training. Is there a way to simplify the process for even the most unfamiliar user?

### Solution

Yes! iFlagger allows the user to just enter the sample information and start the analysis. The software analyzes the data, which is presented in an easy-to-understand window, and the result details can be summarized as one file.

## iFlagger Features

- iFlagger automatically analyzes samples and processes data.
- Easy to understand results.
- Final results can be exported in text or .csv which is convenient for organizing or summarizing data.
- Analysis parameters can be customized for multiple compounds or single compounds.
  - iFlagger includes sample parameters for analyzing the presence of compounds.
  - A variety of parameters can be used in combination to support a wide range of target compounds.

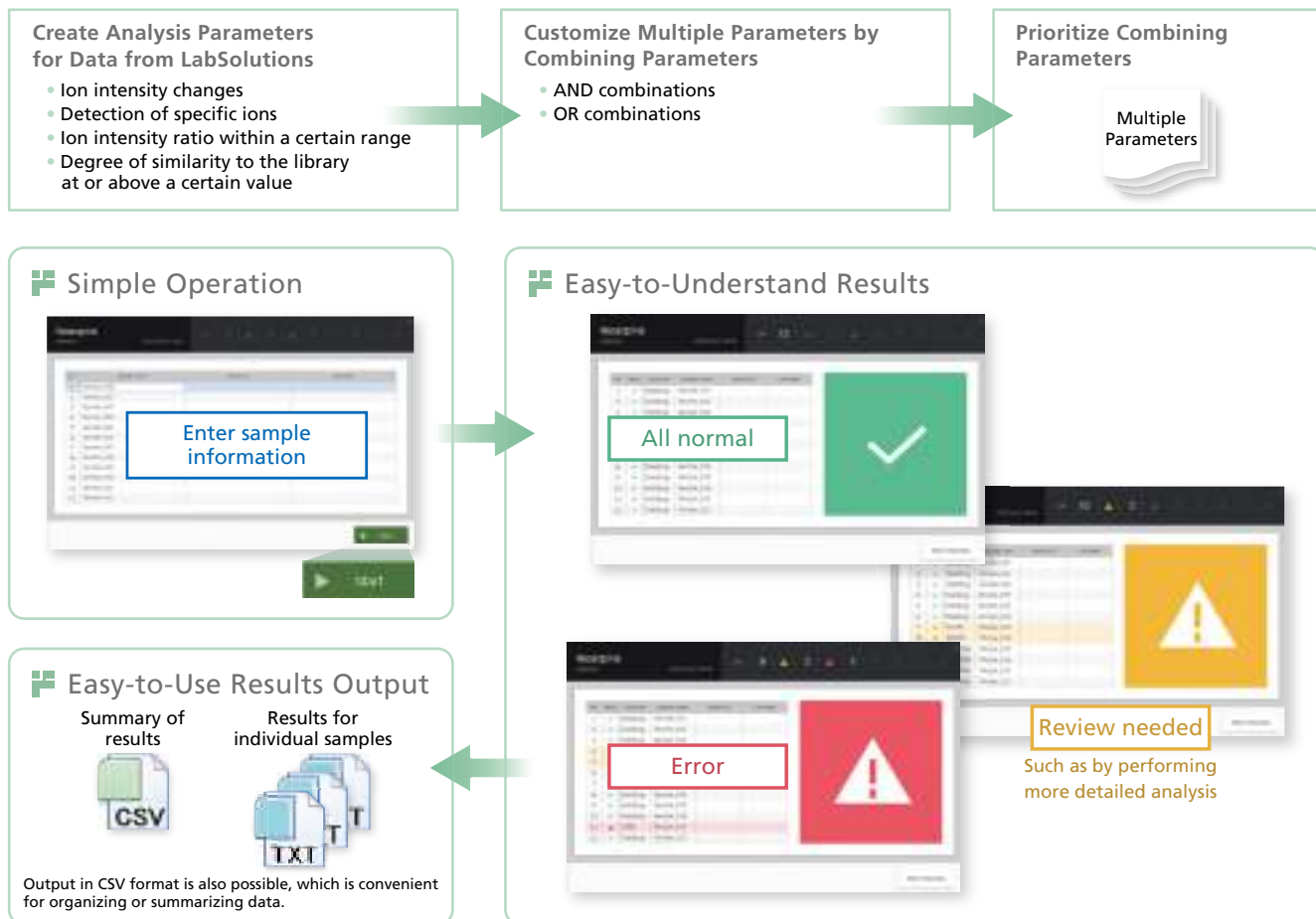

### Precautions

1. LabSolutions LCMS is required for operating iFlagger.
2. Only qualitative analysis can be made with iFlagger. iFlagger cannot be used for quantitative applications.
3. User must be proficient in the concepts behind LCMS and LabSolutions software in order to determine analysis parameters.
4. Please note no warranty, expressed or implied, is provided for the method files or analysis criteria included or for the results obtained.

First Edition: February, 2016



Company names, product/service names and logos used in this publication are trademarks and trade names of Shimadzu Corporation or its affiliates, whether or not they are used with trademark symbol "TM" or "®". Third-party trademarks and trade names may be used in this publication to refer to either the entities or their products/services. Shimadzu disclaims any proprietary interest in trademarks and trade names other than its own.

For Research Use Only. Not for use in diagnostic procedures. The contents of this publication are provided to you "as is" without warranty of any kind, and are subject to change without notice. Shimadzu does not assume any responsibility or liability for any damage, whether direct or indirect, relating to the use of this publication.

Shimadzu Corporation  
[www.shimadzu.com/an/](http://www.shimadzu.com/an/)

© Shimadzu Corporation, 2016  
Printed in Japan 3655-02601-20ANS

# Optional Software for LabSolutions DB LCMS and LabSolutions CS LabSolutions Report Plus™ Software

The Ultimate Software for Assisting in the Creation  
of Reports Freely Configurable with Any Content

By specifying a set of files created with LabSolutions and a report template created with LabSolutions Report Plus, reports can be output according to a desired format.

## Creating User-Defined Reports with Information Freely Arranged in Any Layout

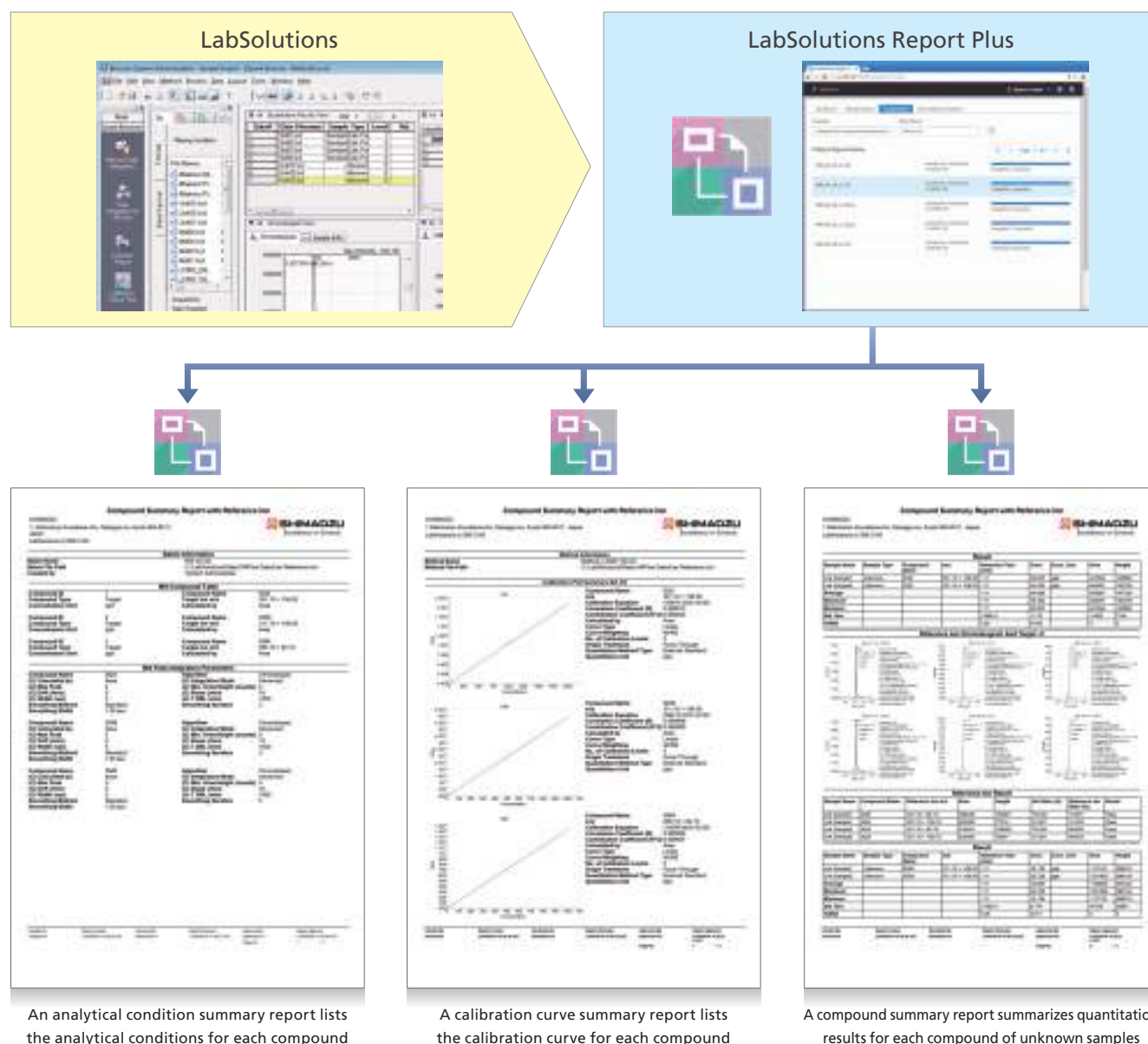

An analytical condition summary report lists the analytical conditions for each compound

A calibration curve summary report lists the calibration curve for each compound

A compound summary report summarizes quantitation results for each compound of unknown samples

## Configure Report Layouts that Contain Only the Necessary Information

By arranging report elements, such as chromatograms, tabulated results, and calibration curves, on a report template, reports can be output in various formats including the following.

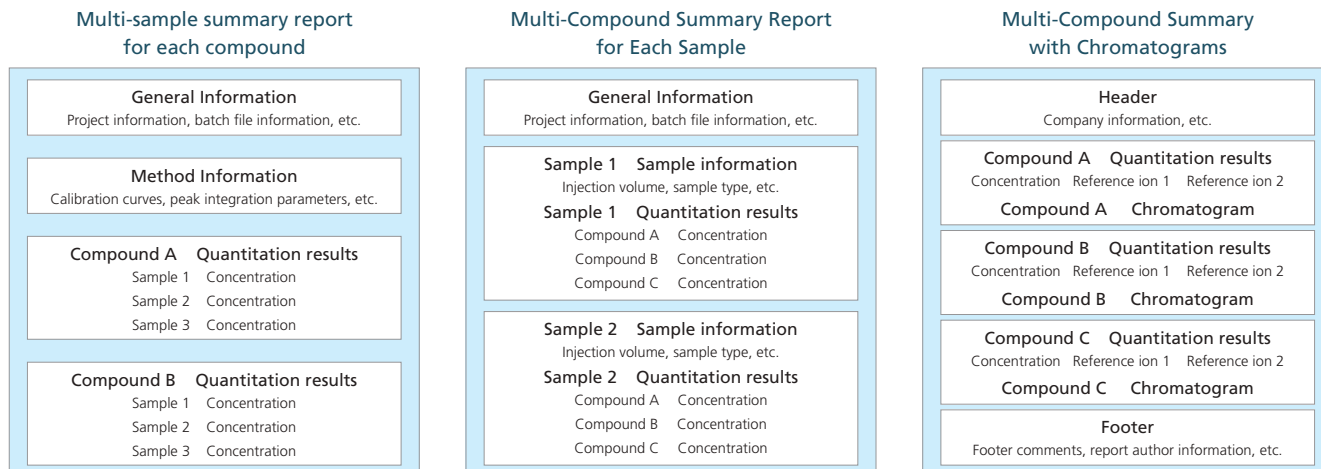

## Workflow Based on User Rights

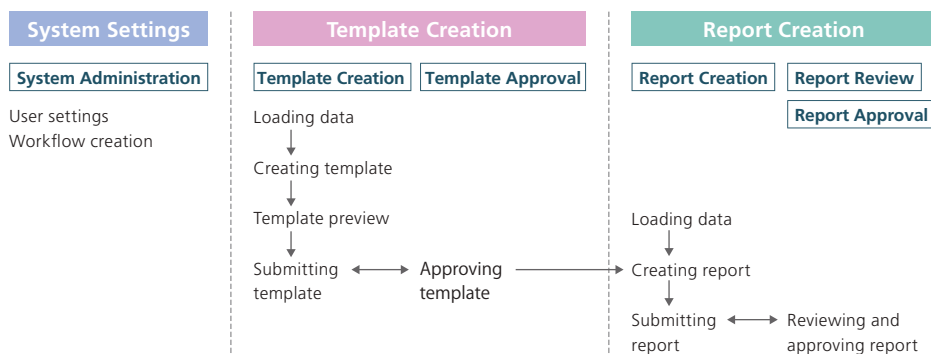

Six user rights levels are provided. These can be used to support the workflow with each report operation. Furthermore, only the functions necessary for the given user rights are displayed, which makes it easy to learn operations.

## 21 CFR Part 11-Compliant Operations Supported

Used in combination with LabSolutions DB LCMS or LabSolutions CS software, LabSolutions Report Plus supports operations required for compliance with the regulation.

## Installation in a Client Computer Is Not Necessary

LabSolutions Report Plus is a web-based application that can be operated at any time from any computer connected to the internal network within a company. \*

\*Requires operation in a client-server system.

Note :

1. This software is available for LabSolutions LCMS.
2. This software only supports analyzed data with the LCMS-8030/8040/8050/8060.



Shimadzu Corporation

[www.shimadzu.com/an/](http://www.shimadzu.com/an/)

**For Research Use Only. Not for use in diagnostic procedure.**

This publication may contain references to products that are not available in your country. Please contact us to check the availability of these products in your country.

Company names, product/service names and logos used in this publication are trademarks and trade names of Shimadzu Corporation or its affiliates, whether or not they are used with trademark symbol "TM" or "®". Third-party trademarks and trade names may be used in this publication to refer to either the entities or their products/services. Shimadzu disclaims any proprietary interest in trademarks and trade names other than its own.

The contents of this publication are provided to you "as is" without warranty of any kind, and are subject to change without notice. Shimadzu does not assume any responsibility or liability for any damage, whether direct or indirect, relating to the use of this publication.

# Application News

## No. G287

### Gas Chromatography

## System Suitability Testing for Hydroxypropyl Cellulose

On December 1, 2014, the quantitative testing section on hydroxypropyl cellulose was modified in Stage 6 Harmonization of the United States Pharmacopeia (USP).

This article introduces examination results of system suitability for quantitative testing of hydroxypropyl cellulose in conformance with the USP.

Y. Nagao, T. Murata

### System Suitability

An internal standard solution (methylcyclohexane in *o*-xylene) and a standard solution of isopropyl iodide were prepared according to the USP monograph.

Using the system and conditions given in Table 1, 2.0  $\mu$ L of the prepared standard solution was injected. Fig. 1 shows the obtained chromatogram.

**System performance:** When operating under the conditions in Table 1, it is stated that isopropyl iodide elutes before the internal standard with a relative retention time of 0.8 with reference to the internal standard, and the resolution is no less than 2.0. The relative retention time of isopropyl iodide and the internal standard (methylcyclohexane) in the chromatogram shown in Fig. 1 was 0.77, and the resolution was 15.70.

**System reproducibility:** It is stated that the relative standard deviation is to be no more than 2.0 % using the response factor calculation (F) for six injections with a standard solution of 2.0  $\mu$ L. Fig. 2 shows the six chromatograms which were used to verify reproducibility. The relative standard deviation using the response factor (F) was 0.32 %.

For reference, Table 2 and 3 are the peak tables produced from analyses of isopropyl iodide and internal standard.

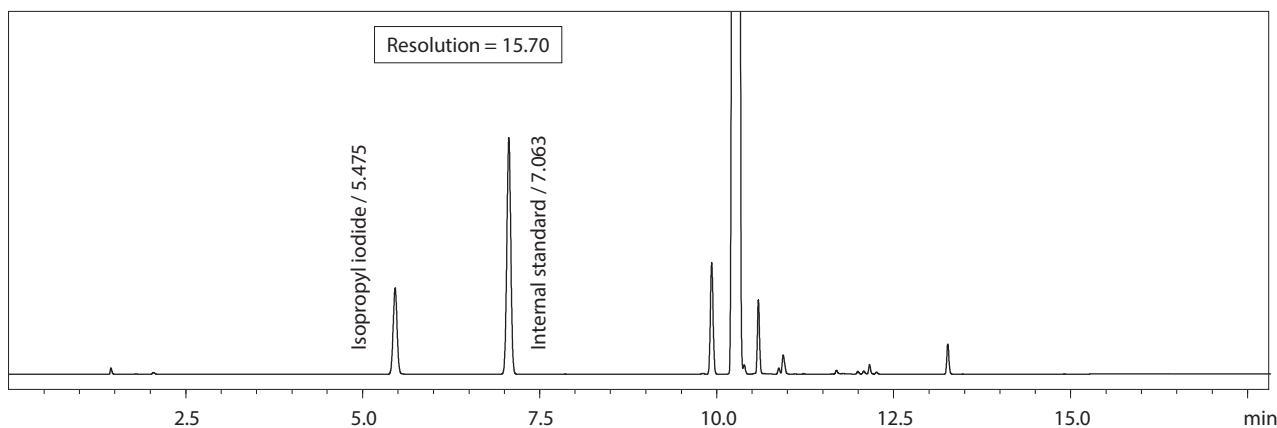
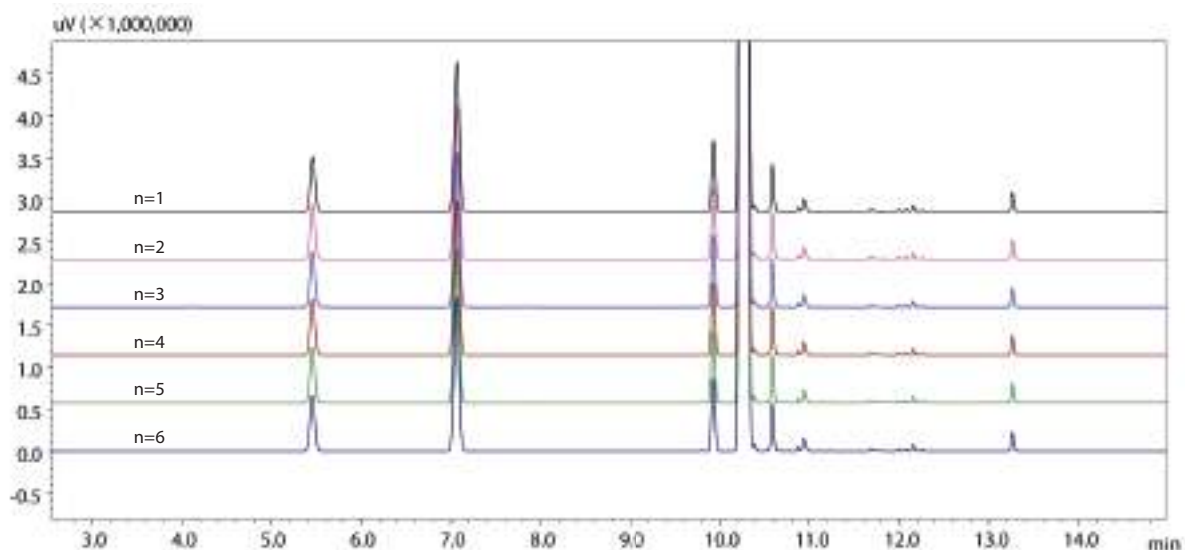

Fig. 1 Chromatogram of Standard Solution

Table 1 Analysis Conditions

Model	: GC-2010Plus AF (230 V) /AOC-20i
Column	: SH-Rtx-1 (30 m, 0.53 mm I.D., df=3.0 $\mu$ m)
Column Temp.	: 40 °C (3 min) - 10 °C/min - 100 °C - 50 °C/min - 250 °C (3 min)
Detector	: FID
Carrier Gas	: He, 52 cm/sec
Inj. Temp.	: 180 °C
Det. Temp.	: 280 °C
Split Ratio	: 1:50
Inj. Volume	: 2.0 $\mu$ L



**Fig. 2 Verification of Chromatogram Reproducibility (n=6)**

**Table 2 Analysis Results of Isopropyl Iodide**

	Retention Time (min)	Peak Area ( $\mu\text{V}\cdot\text{sec}$ )	Peak Height ( $\mu\text{V}$ )
n=1	5.457	2500496	648329
n=2	5.456	2543782	660353
n=3	5.455	2554064	663212
n=4	5.456	2562147	662210
n=5	5.455	2555863	662440
n=6	5.454	2555863	661868
%RSD	0.024	0.886	0.859

**Table 3 Analysis Results of the Internal Standard (Methylcyclohexane)**

	Retention Time (min)	Peak Area ( $\mu\text{V}\cdot\text{sec}$ )	Peak Height ( $\mu\text{V}$ )
n=1	7.063	6907258	1778606
n=2	7.063	7072027	1824079
n=3	7.062	7118386	1832215
n=4	7.061	7145447	1838619
n=5	7.061	7110825	1827032
n=6	7.059	7078672	1835287
%RSD	0.020	1.232	1.219

Note: The above are reference values, not guaranteed values.

Reference  
USP Stage 6 Harmonization (December 1, 2014)

First Edition: Apr. 2017



**For Research Use Only. Not for use in diagnostic procedure.**

This publication may contain references to products that are not available in your country. Please contact us to check the availability of these products in your country.

The content of this publication shall not be reproduced, altered or sold for any commercial purpose without the written approval of Shimadzu. Company names, product/service names and logos used in this publication are trademarks and trade names of Shimadzu Corporation or its affiliates, whether or not they are used with trademark symbol "TM" or "®". Third-party trademarks and trade names may be used in this publication to refer to either the entities or their products/services. Shimadzu disclaims any proprietary interest in trademarks and trade names other than its own.

The information contained herein is provided to you "as is" without warranty of any kind including without limitation warranties as to its accuracy or completeness. Shimadzu does not assume any responsibility or liability for any damage, whether direct or indirect, relating to the use of this publication. This publication is based upon the information available to Shimadzu on or before the date of publication, and subject to change without notice.

Shimadzu Corporation  
www.shimadzu.com/an/

© Shimadzu Corporation, 2017

# Application News

## No. L489

### High Performance Liquid Chromatography

## Analysis of Mannitol Using RID-20A Differential Index Detector

Mannitol possesses characteristics that include low moisture absorption and low reactivity, and is therefore used as an excipient for pharmaceuticals. USP methods for D-mannitol (hereafter, "mannitol") were amended in 2014 to specify the use of refractive index detection with a 7.8 mm × 300 mm L19 column.

The RID-20A differential refractive index detector features an optical system with dual temperature control to absorb the impact of subtle changes in temperature, thereby permitting chromatograms to be generated with a stable baseline. Here, we introduce an example of mannitol analysis using the RID-20A.

### System Suitability

Fig. 1 shows the structural formula of mannitol. The test method for mannitol specifies that two types of system suitability test standard solutions be analyzed. The upper data of Fig. 2 shows the system suitability test results for Standard Solution 1, consisting of isomalt and maltitol standards (each 1 g/L), and the lower data of Fig. 2 shows the results using Standard Solution 2, consisting of mannitol and sorbitol standards (each 25 g/L). Table 1 shows the analytical conditions.

Table 2 shows the reference values for the system suitability test, in addition to the analysis results. The results confirm that system suitability is satisfied with respect to all the criteria.

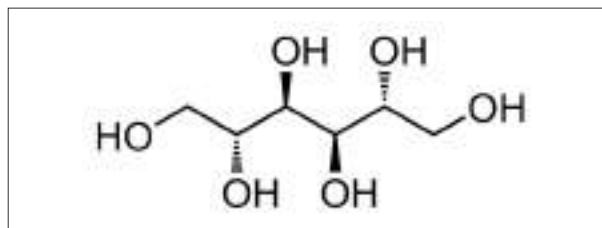

Fig. 1 Structure of D-Mannitol

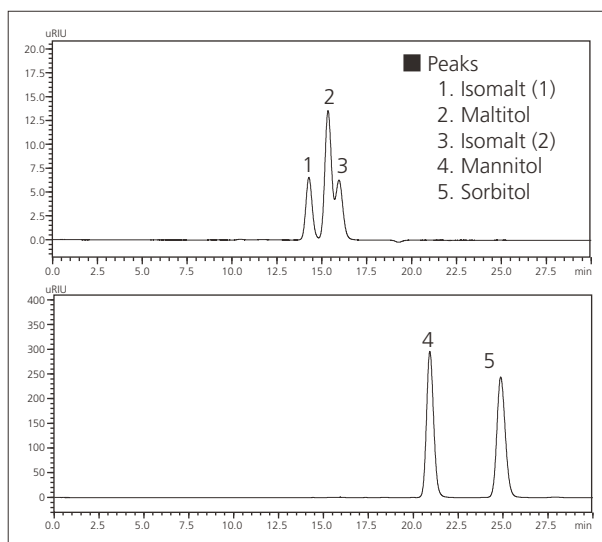

Fig. 2 Chromatograms of a Standard Mixture of Four Sugar Alcohols  
Upper: System Suitability Solution 1 (Isomalt, Maltitol)  
Lower: System Suitability Solution 2 (Mannitol, Sorbitol)

Table 1 Analytical Conditions

System	: Prominence
Column	: Shim-pack SCR-101C (300 mm L. × 7.9 mm I.D., 10 μm)
Mobile Phase	: Water
Flowrate	: 0.5 mL/min
Column Temp.	: 85 °C
Injection Volume	: 20 μL
Detection	: RID-20A

Table 2 Results of System Suitability Test

System Suitability Assessment Item	Target Substance	Reference Value	Analysis Result
Retention Time	Mannitol	Approximately 20 minutes	20.9 minutes
Relative Retention Time with Respect to Mannitol	Isomalt (1)	Approximately 0.6	0.68
	Maltitol	Approximately 0.69	0.73
	Isomalt (2)	Approximately 0.73	0.76
	Sorbitol	Approximately 0.12	1.2
Resolution	Mannitol and sorbitol	Greater than 2.0	5.0
Relative Standard Deviation of Peak Area Value	Mannitol	Less than 1.0 %	0.03 %



■ **Linearity**

Fig. 3 shows the calibration curve of mannitol analyzed using the conditions of Table 1. The correlation coefficient over the concentration range from 1 to 100 g/L is  $R^2 = 0.999$ , demonstrating excellent linearity.

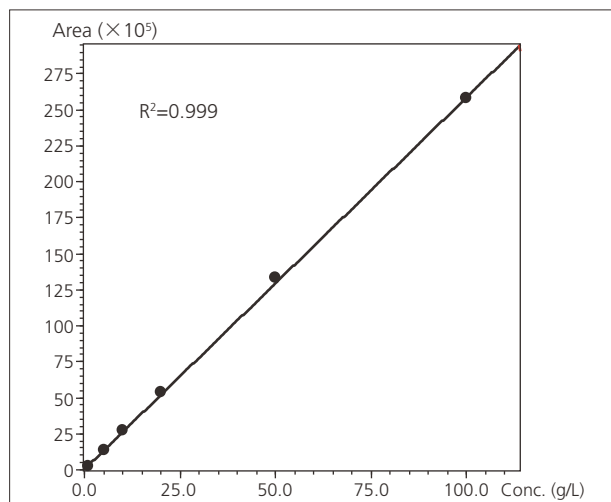

Fig. 3 Linearity of Calibration Curve

■ **Effect of Column Temperature**

Fig. 4 shows the chromatograms obtained in analysis of the four sugar alcohol standard samples using the two column oven temperatures of 85 °C and 60 °C. The upper pair of chromatograms are those of isomalt and maltitol, and the lower pair, of mannitol and sorbitol. When the column temperature is lowered to 60 °C, the retention time of mannitol becomes 23 minutes, at which point the system suitability requirement is no longer satisfied.

When analysis is conducted at a high column temperature like 85 °C, it is important that the temperature be maintained uniformly over the entire length of the column. The CTO-20AC column oven used in this analysis is equipped with forced air circulation, thereby permitting stable analysis even at high temperatures.

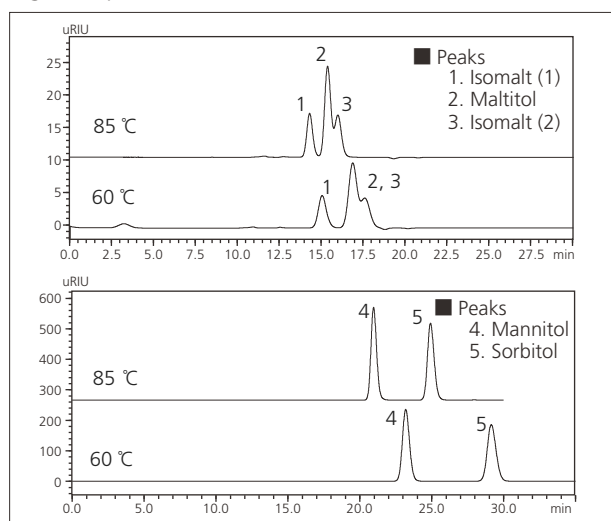

Fig. 4 Chromatograms of a Standard Mixture of Four Sugar Alcohols (85 °C, 60 °C)

■ **Analysis of a Pharmaceutical Excipient**

Fig. 5 shows an example of analysis of a pharmaceutical excipient, consisting mainly of mannitol, using a 20  $\mu$ L injection of 50 g/L sample solution. The chromatogram of the excipient is shown in the upper portion of the figure, while an expanded view of the chromatogram is shown in the lower portion. Trace levels of other substances, including sorbitol and isomalt, were also detected in the excipient.

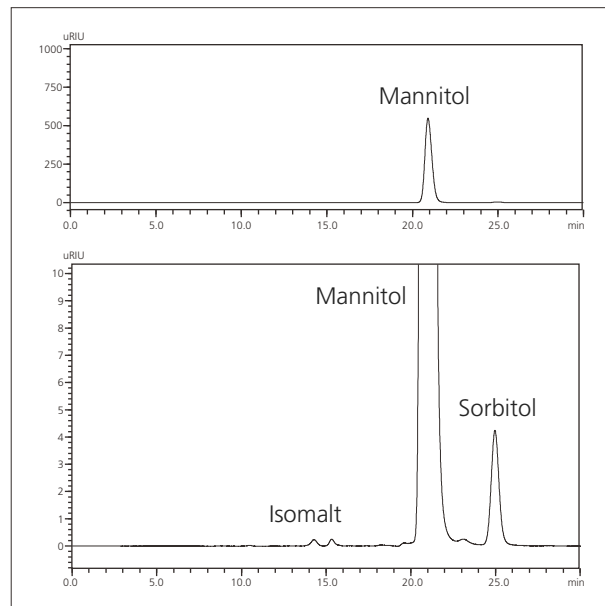

Fig. 5 Chromatogram of Pharmaceutical Excipient  
Upper: Chromatogram  
Lower: Expanded Chromatogram

Reference

- 1) United States Pharmacopeia, Second Supplement to USP 37-NF 32

The samples used to produce this application were kindly provided by Nihon Generic Co., Ltd.

# Application News

## No. G290

### Gas Chromatograph

## Analysis of Residual Solvents in drug products using Nexis GC-2030 combined with HS-20 head space sampler - USP <467> Residual Solvents Procedure A -

Residual solvents in pharmaceuticals are defined as volatile organic compounds used in or generated from the manufacture of drug substances, pharmaceutical additives, or drug products. They are strictly controlled according to risk classifications from Class 1 to Class 3, which are based on the risk to human health.

Headspace GC methods specified in the USP (U.S. Pharmacopeia), General Chapters <467> Residual Solvents, are commonly used for analysis of residual solvents. This Application News presents data obtained using the Shimadzu HS-20 Headspace Sampler and Nexis GC-2030 Gas Chromatograph, from Class 1 and Class 2 standard solutions, in accordance with Water-Soluble Articles, Procedure A, in USP <467> Residual Solvents.

E. Kobayashi, T. Murata



Fig. 1 Nexis GC-2030 + HS-20

### Class 1

Fig.2 shows the Class 1 standard solution chromatogram. Procedure A requires that the S/N ratio obtained for 1,1,1-Trichloroethane in this chromatogram be 5 or higher. As shown, the S/N ratio was 220. Even for carbon tetrachloride, which had the lowest sensitivity level, the S/N was 20.

Table 3 indicates the S/N ratio of each peaks and the repeatability of the peak area (n=6).

Table 3 S/N ratio and Repeatability of Class1

No.	Compounds	S/N ratio	%RSD (n=6)
1	1,1-Dichloroethane	320	2.8
2	1,1,1-Trichloroethane	220	2.3
3	Carbon tetrachloride	20	2.9
4	Benzene	170	2.5
5	1,2-Dichloroethane	60	3.4

### Instruments and Analytical Conditions

Table 1 GC Method for USP 467 Procedure A

Model	: Nexis GC-2030
Detector	: FID-2030
Headspace Sampler	: HS-20
Column	: SH-Rxi-624 Sil MS (0.32 mm I.D. x 30 m, d.f. = 1.8 μm)
Column Temperature	: 40 °C (20 min) - 10 °C/min - 240 °C (20 min) Total 60 min
Injection Mode	: Split 1 : 5
Carrier Gas Controller	: Constant Linear Velocity (He)
Linear Velocity	: 35 cm/sec
Detector Temperature	: 250 °C
FID H <sub>2</sub> Flow Rate	: 40 mL/min
FID Make up Flow Rate	: 30 mL/min (He)
FID Air Flow Rate	: 400 mL/min
Injection Volume	: 1 mL

Table 2 HS-20 Method for USP 467 Procedure A

Oven Temperature	: 80 °C
Sample Line Temperature	: 110 °C
Transfer Line Temperature	: 120 °C
Vial Stirring	: Off
Vial Volume	: 20 mL
Vial Heat-retention Time	: 60 min
Vial Pressurization Time	: 1 min
Vial Pressure	: 75 kPa
Loading Time	: 1 min
Needle Flush Time	: 5 min

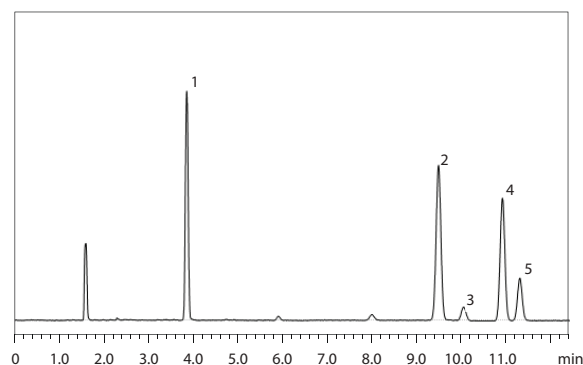

Fig. 2 Chromatogram of WATER-SOLUBLE ARTICLES Class1 Standard Solution by Procedure A

■ Class2

Due to the large number of components in the Class 2 standard solution, it was separated into two mixtures: A and B. Respective measurement results are shown in Fig.3 and Fig.4. Procedure A requires that the resolution for acetonitrile and methylene chloride in

the Class 2 standard solution Mixture A chromatogram be 1.0 or greater.

Fig.3 shows that, using the Restek SH-Rxi-624SiIMS low-bleed column, the specified peaks are completely separated, with a resolution of 2.4.

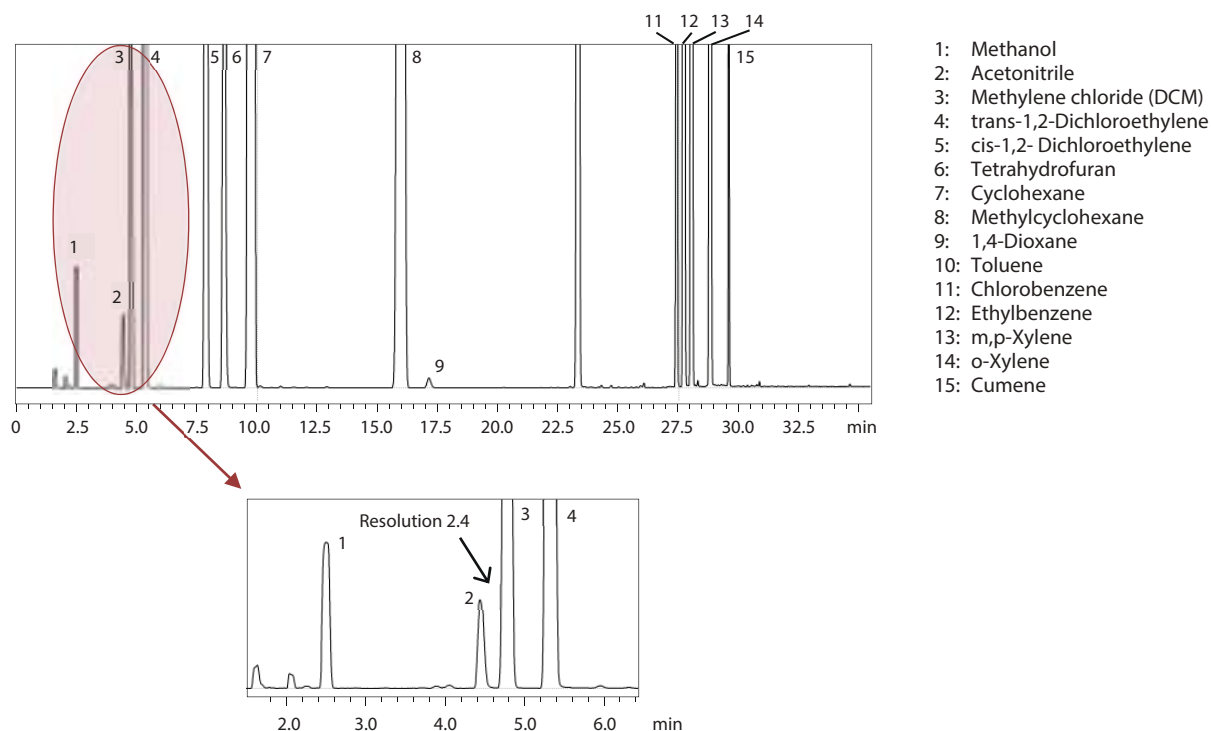

Fig. 3 Chromatogram of WATER-SOLUBLE ARTICLES Class 2A Standard Solution by Procedure A

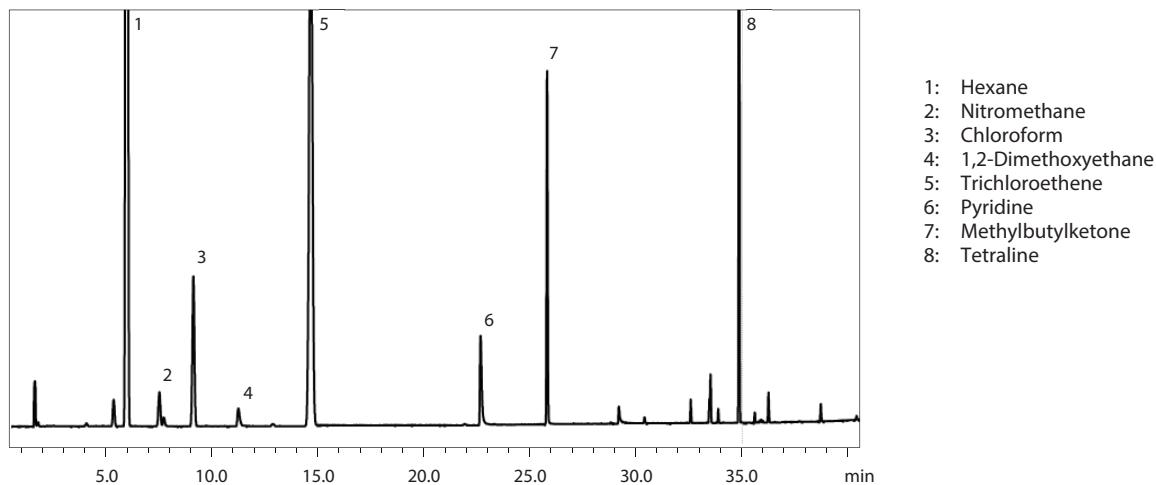

Fig. 4 Chromatogram of WATER-SOLUBLE ARTICLES Class 2B Standard Solution by Procedure A

First Edition: Jun. 2017



For Research Use Only. Not for use in diagnostic procedure.

This publication may contain references to products that are not available in your country. Please contact us to check the availability of these products in your country.

The content of this publication shall not be reproduced, altered or sold for any commercial purpose without the written approval of Shimadzu. Company names, product/service names and logos used in this publication are trademarks and trade names of Shimadzu Corporation or its affiliates, whether or not they are used with trademark symbol "TM" or "®". Third-party trademarks and trade names may be used in this publication to refer to either the entities or their products/services. Shimadzu disclaims any proprietary interest in trademarks and trade names other than its own.

The information contained herein is provided to you "as is" without warranty of any kind including without limitation warranties as to its accuracy or completeness. Shimadzu does not assume any responsibility or liability for any damage, whether direct or indirect, relating to the use of this publication. This publication is based upon the information available to Shimadzu on or before the date of publication, and subject to change without notice.

Shimadzu Corporation  
www.shimadzu.com/an/

# Application News

## No. M272

### Gas Chromatography Mass Spectrometry

## Analysis of Residual Solvents in Pharmaceuticals Using Headspace GC-FID/MS Detector Splitting System

Headspace gas chromatography with flame ionization detection (GC-FID) is often used for residual solvent testing of pharmaceuticals, though the qualitative power of this method is not particularly high. Because gas chromatography mass spectrometry (GC/MS) utilizes MS to perform qualitative analysis based on mass spectra, GC/MS can be used to estimate and identify individual peaks detected in the expected vicinity of a target solvent as well as other unknown peaks.

We describe an example of residual solvent test of a pharmaceutical using a detector splitting system that simultaneously obtains FID and MS data in a single measurement.

#### Sample Preparation

According to Water-Soluble Articles, Procedure A, in USP <467>, we prepared a class 1 standard solution, class 2 standard solution A, class 2 standard solution B, test solution, and class 1 system suitability solution. An active pharmaceutical ingredient was used for the test solution sample.

#### Analytical Conditions

The image of the Shimadzu GCMS-QP2020/FID detector splitting system is shown in Fig. 1, and analytical conditions are shown in Table 1. Headspace conditions were determined based on USP <467>. The column outlet was split between FID and MS, and MS was performed in scanning mode. Using Shimadzu's Advanced Flow Technology Software to determine the splitting ratio, the flowrate ratio was optimized to FID:MS of 1:1.

**Table 1 Analytical Conditions**

Headspace Sampler	: HS-20
GCMS	: GCMS-QP2020
Hydrogen Flame Ionization Detector Splitting System	: FID-2010Plus
<b>HS</b>	
Mode	: Loop (volume 1 mL)
Oven Temp.	: 80 °C
Sample Line Temp.	: 90 °C
Transfer Line Temp.	: 105 °C
Gas Pressure for Vial Pressurization	: 76.4 kPa
Vial Equilibrating Time	: 45 min
Vial Pressurizing Time	: 2.0 min
Pressure Equilibrating Time	: 0.1 min
Load Time	: 0.5 min
Load Equilibrating Time	: 0.1 min
Injection Time	: 0.5 min
Needle Flushing Time	: 15.0 min
APC Pressure	: 20 kPa
<b>GC</b>	
Column	: SH Rxi-624sil MS (30 m × 0.32 mm I.D., 1.8 μm)
Injection Mode	: Split (split ratio 1:5)
Control Mode	: Constant Pressure (89.4 kPa)
Carrier Gas	: He
Oven Temp.	: 40 °C (20 min) → 10 °C/min → 240 °C (20 min)
Restrictor (FID)	: 1.1 m × 0.25 mm
Restrictor (MS)	: 1.5 m × 0.20 mm
APC Pressure	: 20 kPa
<b>FID</b>	
Temp.	: 250 °C
Make-Up Flowrate	: 30 mL/min (He)
Hydrogen Flowrate	: 40 mL/min
Air Flowrate	: 400 mL/min
<b>MS</b>	
Ion Source Temp.	: 200 °C
Interface Temp.	: 250 °C
SCAN Range	: <i>m/z</i> 29 to 250
Event Time	: 0.3 sec

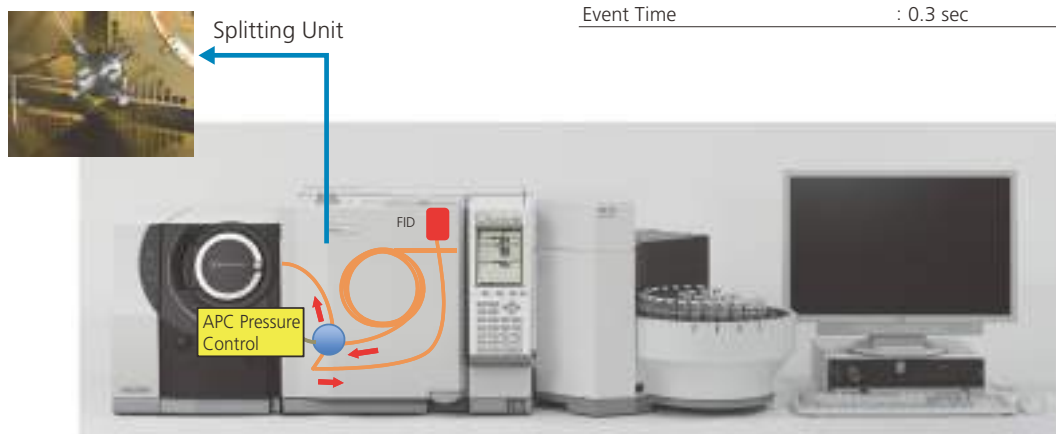

**Fig. 1 System Image**

■ Results

Fig. 2 to 5 show the FID and MS chromatograms obtained for class 1 standard solution, class 2 standard solution A, class 2 standard solution B, and class 1 system suitability solution.

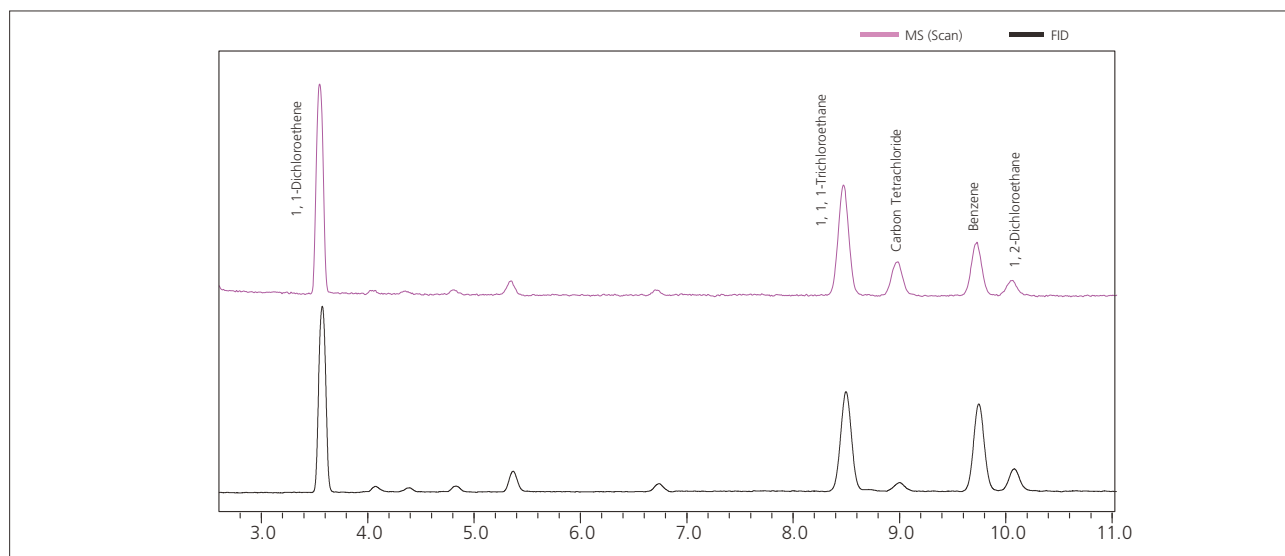

Fig. 2 Chromatograms of Class 1 Standard Solution

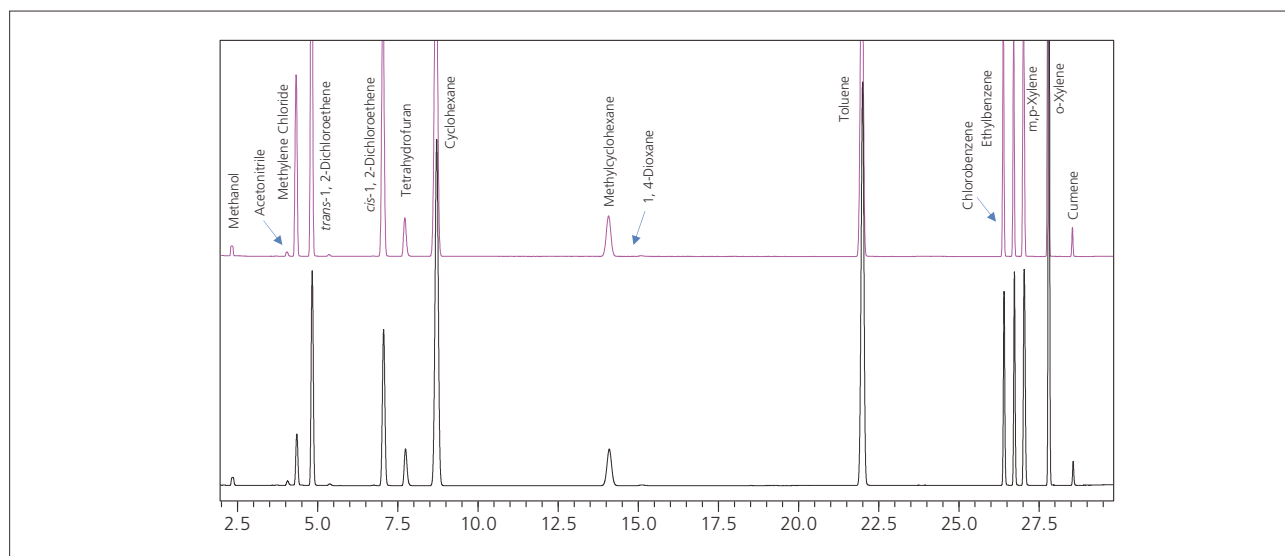

Fig. 3 Chromatograms of Class 2 Mixture A Standard Solution

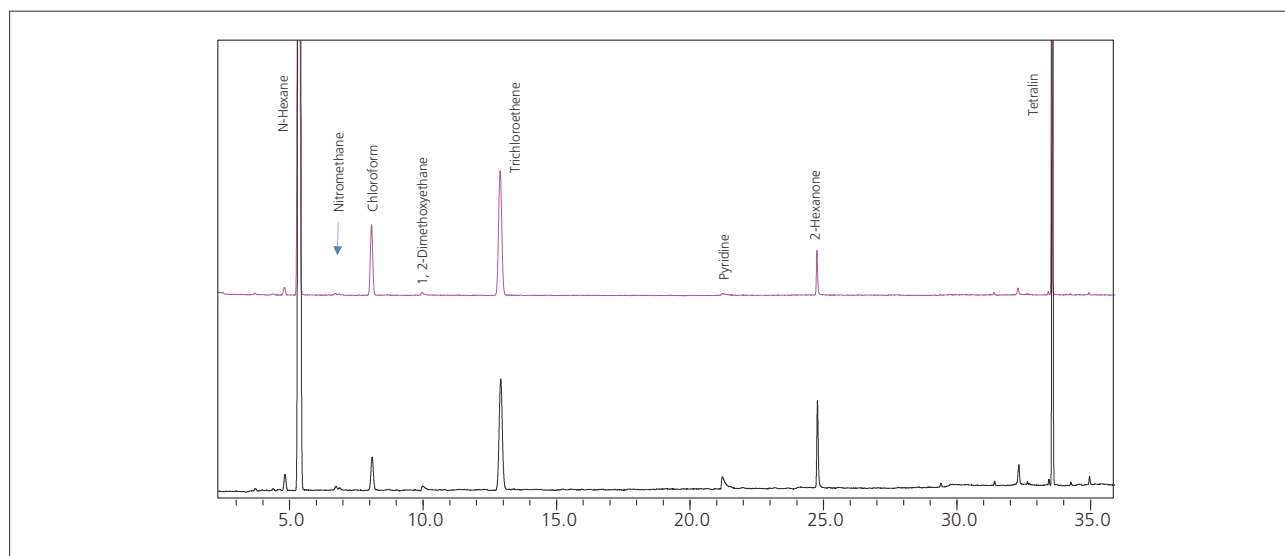

Fig. 4 Chromatograms of Class 2 Mixture B Standard Solution

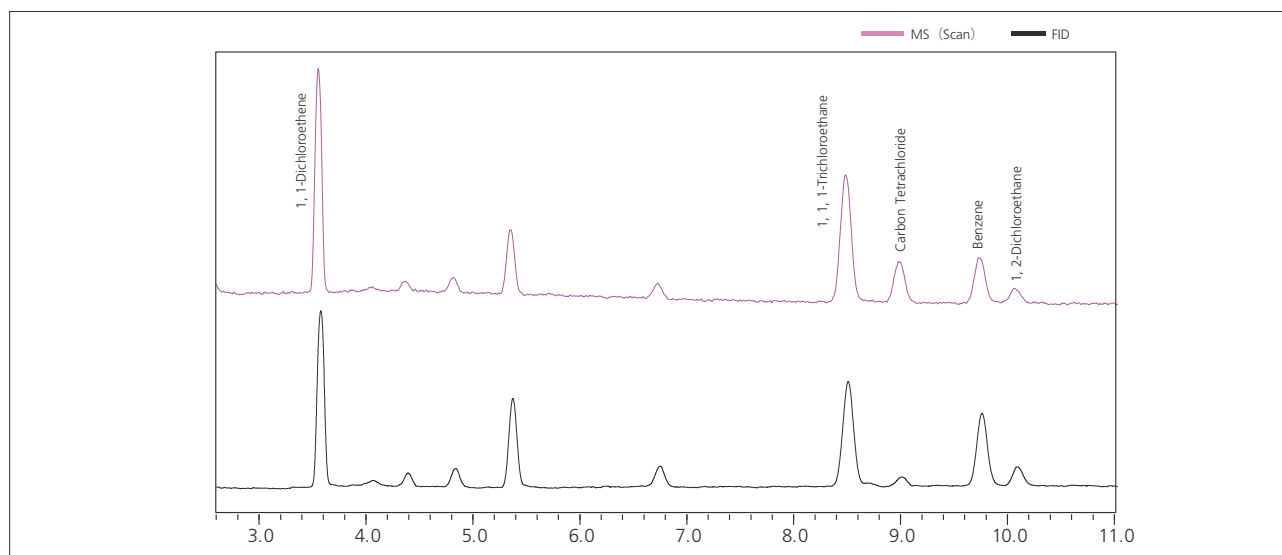

Fig. 5 Chromatograms of Class 1 System Suitability Solution

To check the mass spectra of the peaks detected by FID, the peak retention times in chromatograms obtained by FID and MS must match as closely as possible. Looking at Fig. 2 to 4 show all the peak retention times are lined up, from the earliest to the latest constituent.

When using a detector splitting system, the two detectors must detect the same peaks detected by normal gas chromatography. In other words, detector splitting systems are expected to have the equivalent system performance as a normal analytical system. Procedure A in USP <467> states the two items below concerning system suitability. We attempted to confirm the two items below for the detector splitting system, and for the repeatability of class 1 standard solution analysis.

(1) Detector confirmation

The S/N ratio of 1, 1, 1-trichloroethane in class 1 standard solution is 5 or higher; the S/N ratio of each peak in class 1 system suitability solution is 3 or higher.

(2) System performance

The peak resolution between acetonitrile and dichloromethane in class 2 standard solution is 1.0 or higher.

The results (FID S/N ratios) of analyzing class 1 standard solution and class 1 system suitability solution with the detector splitting system are shown in Table 2, and the repeatability results (FID repeatability) of analyzing class 1 standard solution are shown in Table 3. These results show the detector splitting system meets the performance required of a standard system. The peak resolution of acetonitrile and dichloromethane in class 2 standard solution was 2.37, showing this system is also suitable in terms of resolution.

Table 2 Signal-to-Noise Ratio in Class 1 Standard Solution and System Suitability Solution

Compound	Standard solution	Solution for system suitability test
1, 1-Dichloroethene	221.9	141.4
1, 1, 1-Trichloroethane	117.6	82.2
Carbon tetrachloride	10.2	7.6
Benzene	106.3	56.8
1, 2-Dichloroethane	26.4	14.2

Table 3 Repeatability in Class 1 Standard Solution (n=6)

Compound	Relative standard deviation (%)
1, 1-Dichloroethene	1.6
1, 1, 1-Trichloroethane	2.2
Carbon tetrachloride	1.8
Benzene	3.5
1, 2-Dichloroethane	2.9

The results (chromatograms) of analyzing active pharmaceutical ingredients in the detector splitting system are shown in Fig. 6, and the mass spectra of detected peaks are shown in Fig. 7 to 9. Peaks a and b, based on their respective mass spectra (Fig. 7 and 8), were estimated to be ethyl acetate and butanol. Both these constituents are low toxicity class 3 solvents.

Though its peak strength is smaller than that observed in the standard solution, a peak was also detected at the elution position of o-xylene (c). Checking the mass spectrum of this peak (Fig. 9) showed it differed from the mass spectrum of xylene (peak d, Fig. 10), and was estimated to be dibutyl ether.

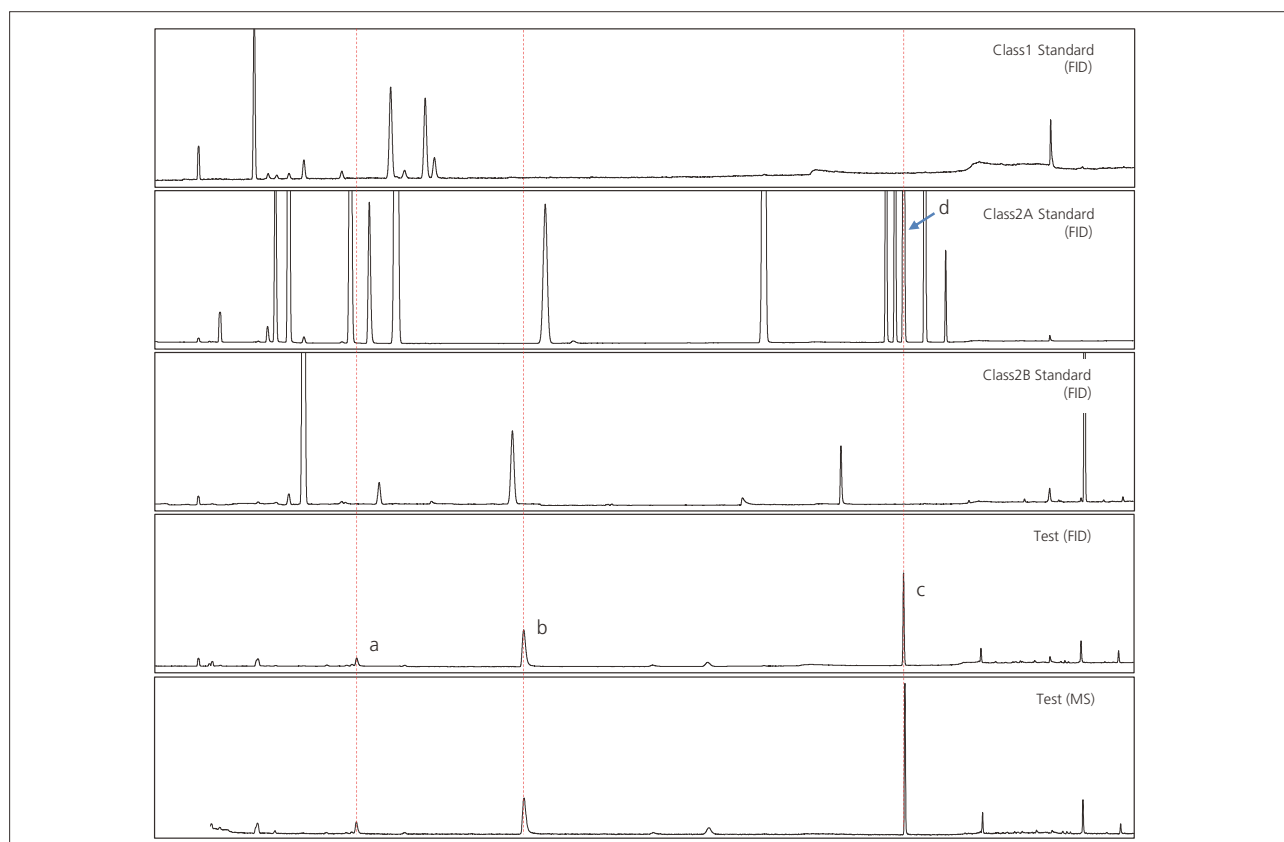

Fig. 6 Chromatograms of Standard Solutions and Test Solutions

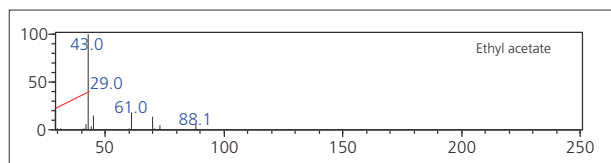

Fig. 7 Mass Spectrum of Peak a

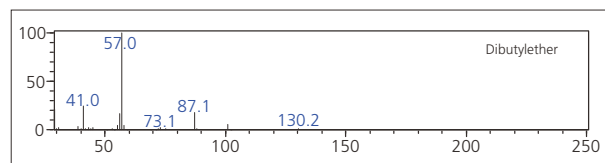

Fig. 9 Mass Spectrum of Peak c

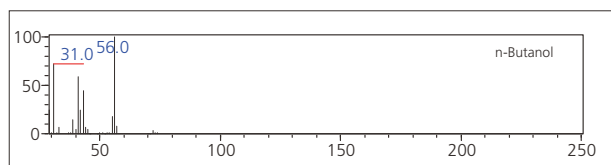

Fig. 8 Mass Spectrum of Peak b

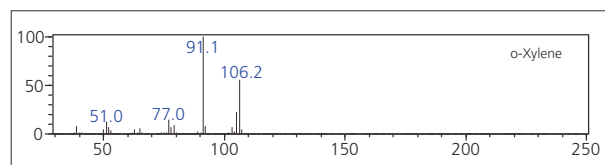

Fig. 10 Mass Spectrum of Peak d

### Conclusion

An FID and MS detector splitting system obtains FID and MS data simultaneously in a single analysis, and can be used as a simpler method of confirming constituent identity. This system shows promise for use in residual solvent testing of pharmaceuticals.

Note: Reference USP <467>

This data was obtained by a method that does not conform to the pharmacopoeia, as analytical conditions based on USP <467> was modified before use.

First Edition: Jul. 2016



For Research Use Only. Not for use in diagnostic procedure.

This publication may contain references to products that are not available in your country. Please contact us to check the availability of these products in your country.

The content of this publication shall not be reproduced, altered or sold for any commercial purpose without the written approval of Shimadzu. Company names, product/service names and logos used in this publication are trademarks and trade names of Shimadzu Corporation or its affiliates, whether or not they are used with trademark symbol "TM" or "@". Third-party trademarks and trade names may be used in this publication to refer to either the entities or their products/services. Shimadzu disclaims any proprietary interest in trademarks and trade names other than its own.

The information contained herein is provided to you "as is" without warranty of any kind including without limitation warranties as to its accuracy or completeness. Shimadzu does not assume any responsibility or liability for any damage, whether direct or indirect, relating to the use of this publication. This publication is based upon the information available to Shimadzu on or before the date of publication, and subject to change without notice.

Shimadzu Corporation  
www.shimadzu.com/an/

Gas Chromatograph

# *Nexis* GC-2030



## The Next Industry Standard

Nexis GC-2030, Shimadzu's premier gas chromatograph, offers a modern approach to a classic chromatographic technique. Designed with the user in mind, new innovative features, exceptional performance and high-throughput capabilities will elevate your lab to the next level.

### Designed with the Analyst in Mind

An advanced interface enables intuitive operation with clear graphics. Shimadzu's latest tool-free maintenance technology makes daily maintenance easy.

### World's Highest\*<sup>1</sup> Sensitivity and Reproducibility

Achieves the world's highest\*<sup>1</sup> sensitivity on the all of the detectors, such as FID and BID. The advanced flow controller (AFC) enhances reliability with excellent repeatability.

### Exceptional Expandability and Productivity

Nexis GC-2030 can be customized to meet a customers' specific requirements and needs. Options and functions to use hydrogen carrier gas safely in high-speed analysis maximize analysis productivity.





## Information at Your Finger-tips

Analysts will benefit from the touch panel interface, which features clear graphics that display information instantly whenever needed. The user-friendly interface leaves the operator free to focus on obtaining optimal analytical results.

Main settings controllable via the touch panel on the GC unit:

- Analytical conditions
- Self-diagnostics
- Automatic carrier gas leak check
- Chromatogram display, etc.

## Tool-free Column Installation

ClickTek connectors\*2 make tool free column installation a snap. The click sensation felt when finished attaching the column provides a more reliable connection and ensures a better seal under all operating conditions.

\*2 Optional



ClickTek Connector

## One Touch Inlet Maintenance

The injection port can be opened or closed without tools by simply sliding the ClickTek lever. Replace the insert, slide the lever and feel the click for a leak-free install every time.



ClickTek Nut

## High-Sensitivity Detectors Support a Wide Variety of Analyses

The jet and collector structure on the flame ionization detector (FID-2030) has been optimized to provide improved performance. Noise levels were also decreased by improving the stability of the signal processor and flow controller. This results in the world's most\*1 sensitive FID. This makes the Nexis GC-2030 the best choice to measure residual solvents in pharmaceuticals.

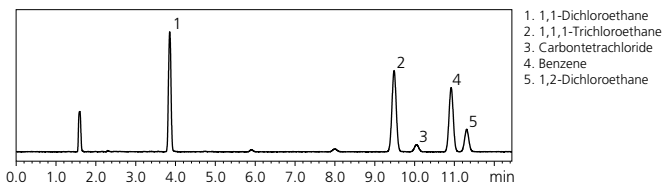

Analysis of Trace Residual Solvents in Pharmaceuticals Using Headspace GC, Class 1 Standard Solution

## GC Systems Customized for Specific Needs

The Nexis GC-2030 provides powerful support for configuring custom GC systems tailored to user needs. These systems are adjusted and tested at the factory for the given application before shipment, so they are ready to use for measurements as soon as they are delivered. That means no time is required for developing methods after the system arrives. Two TCD detectors and one FID detector can be installed at the same time. An optional valve box can be added to control up to eight valves from the original four.

### Examples of System GC Configurations

#### Gasoline analysis system

This system is able to measure specific substances in gasoline, such as oxygenates.

#### Natural gas analysis system

This system is able to analyze components in natural gas, such as shale gas.

#### Inorganic gas analysis system

This system is able to measure hydrogen and various other inorganic gases.

#### Hydrocarbon analysis system

This system is able to measure hydrocarbons that are generated, such as from catalyst reactions.

#### Refinery gas analysis system

This system is able to analyze components in gas from petroleum refineries.

#### Public utility natural gas analysis system

This system is able to calculate calorific values from measurements of natural gas.



\*1 As of May 2017, according to a Shimadzu survey



Shimadzu Corporation

[www.shimadzu.com/an/](http://www.shimadzu.com/an/)

**For Research Use Only. Not for use in diagnostic procedures.**

This publication may contain references to products that are not available in your country. Please contact us to check the availability of these products in your country.

Company names, product/service names and logos used in this publication are trademarks and trade names of Shimadzu Corporation or its affiliates, whether or not they are used with trademark symbol "TM" or "®". Third-party trademarks and trade names may be used in this publication to refer to either the entities or their products/services. Shimadzu disclaims any proprietary interest in trademarks and trade names other than its own.

The contents of this publication are provided to you "as is" without warranty of any kind, and are subject to change without notice. Shimadzu does not assume any responsibility or liability for any damage, whether direct or indirect, relating to the use of this publication.

© Shimadzu Corporation, 2017  
First Edition: May 2017, Printed in Japan 3655-05713-30ANS

# Using GCMS to Test for Residual Solvents in Pharmaceuticals

## 1 Introduction

The HS-GC-FID method is used to test for residual solvents in pharmaceuticals, but GC-MS is useful for identifying peaks in close proximity or for qualifying unknown peaks. However, to qualify peaks detected by GC-FID using GC-MS requires matching chromatogram patterns. The advanced flow controller (AFC) in GC-2010 Plus systems includes constant linear velocity control as standard functionality. This allows achieving similar retention time and separation patterns in GC-FID and GC-MS chromatograms by specifying the same linear velocity setting, provided the columns are identical or columns with the same phase ratio are used.

## 2 Analytical Conditions to Test for Residual Solvents in Pharmaceuticals

Testing for residual solvents in pharmaceuticals involves using a separation column with a 0.53 mm (or 0.32 mm) internal diameter, 30 m length, and 3.0  $\mu\text{m}$  (or 1.8  $\mu\text{m}$ ) thick cyanopropyl phenyl-based liquid phase and separation conditions with a linear carrier gas speed of 35 cm/sec (Procedure A). However, those separation conditions cannot be achieved using GC-MS, due to the negative pressure (vacuum) at the column outlet. Therefore, the typical method used to obtain similar chromatogram patterns is to downsize the column to one with a small internal diameter, so that the phase ratio (ratio of column internal diameter to film thickness) is the same.

SH Rxi-624sil MS  
0.32 mm I.D., 30 m long, and 1.8  $\mu\text{m}$   
film thickness



SH Rxi-624sil MS  
0.25 mm I.D., 30 m long, and 1.4  $\mu\text{m}$   
film thickness

This results in similar chromatogram patterns using the same linear velocity of 35 cm/sec.

Control by the AFC takes into consideration the difference in column outlet pressure between GC and GC-MS. For HS-GCMS analysis, it simply requires changing the column and specifying a 35 cm/sec linear velocity in the method parameter selection window in GCMSsolution. During analysis, the AFC controls the carrier gas automatically, which eliminates the inconvenience of having to adjust pressure or other settings.

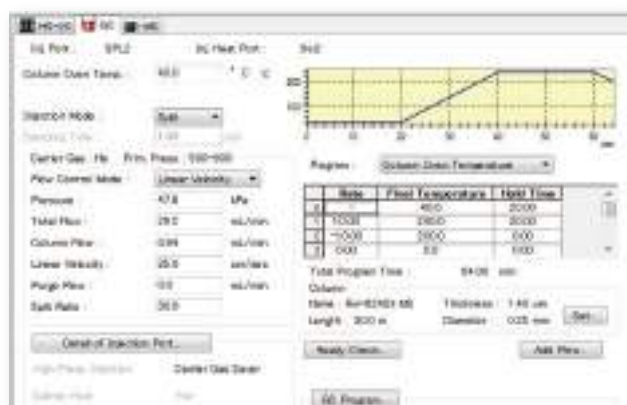

### GCMS-QP2020 + HS-20 + FID-2010 Plus Detector

By including an FID detector in the HS-GCMS system, either analytical method can be used. Contact a Shimadzu representative regarding changing the system configuration, which can be modified to accommodate various user requirements.

### 3 Comparison of GC-FID and GC-MS Chromatograms

After using a GC-FID system to acquire data from a Class 2 standard solution A, data were acquired using a GC-MS system with the same linear velocity condition (35 cm/sec). Then the resulting chromatograms were compared. The comparison shows that the shift in retention times between FID and MS data was 0.02 minutes (1.2 seconds) for acetonitrile, which elutes early, and for cumene, which elutes late. In addition, both chromatograms were similar, with approximately the same separation patterns.

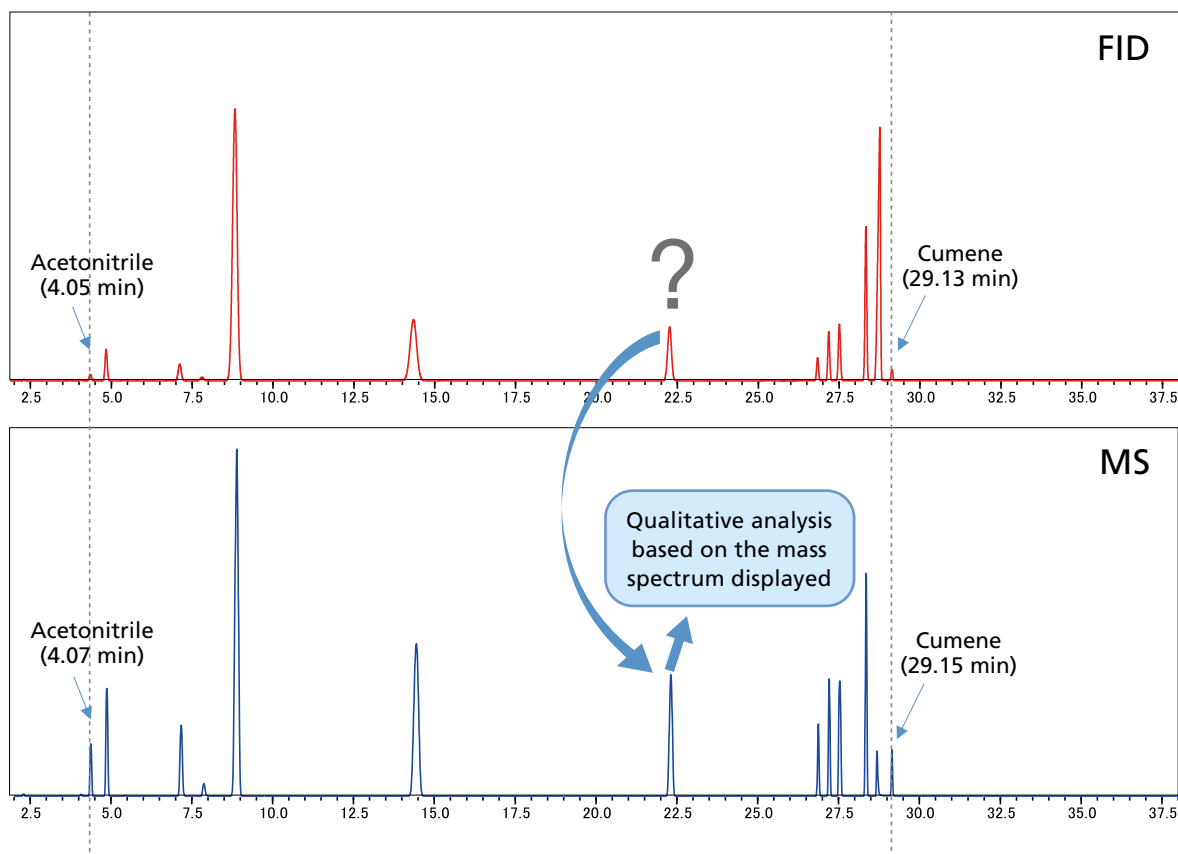

The GC-MS data showed a peak at roughly the same retention time as for the unknown peak detected by the GC-FID system. This peak can be identified easily by qualitative analysis, such as by displaying the mass spectrum and using an MS spectral library to search for a similar peak pattern.

### 4 Summary

If a HS-GC-MS system is used for qualitative analysis in testing for residual solvents in pharmaceuticals, it is important that the chromatogram pattern obtained is similar to the chromatogram obtained from HS-GC-FID analysis. The constant linear velocity control mode for the AFC unit included in Shimadzu GC-MS systems can be used in combination with a Shimadzu HS-20 headspace sampler. Even if the different-sized columns are used for HS-GC-FID and HS-GC-MS analysis, chromatograms with similar retention times and separation patterns can be obtained easily by using columns with the same phase ratio and by specifying the same linear velocity setting, which means GC-MS data can easily be used for qualitative analysis.



Shimadzu Corporation  
[www.shimadzu.com/an/](http://www.shimadzu.com/an/)

**For Research Use Only. Not for use in diagnostic procedures.**

This publication may contain references to products that are not available in your country. Please contact us to check the availability of these products in your country.

Company names, products/service names and logos used in this publication are trademarks and trade names of Shimadzu Corporation, its subsidiaries or its affiliates, whether or not they are used with trademark symbol "TM" or "®".

Third-party trademarks and trade names may be used in this publication to refer to either the entities or their products/services, whether or not they are used with trademark symbol "TM" or "®".

Shimadzu disclaims any proprietary interest in trademarks and trade names other than its own.

The contents of this publication are provided to you "as is" without warranty of any kind, and are subject to change without notice. Shimadzu does not assume any responsibility or liability for any damage, whether direct or indirect, relating to the use of this publication.

# GCMS Solutions for Pharmaceuticals

## Testing for Residual Solvents in Pharmaceuticals: HS-GCMS System with FID Detector

The headspace-GC (FID) method specified in the Japanese Pharmacopoeia is normally used to test for residual solvents in pharmaceuticals. However, unknown peaks not from target solvents sometimes appear during testing. GC-MS can be useful for qualitatively analyzing those peaks.

Since GC-MS systems can be equipped with an FID detector, the same system can be used for both GC-MS and GC analysis.



GCMS-QP2020 + HS-20 + FID-2010 Plus Detector

The constant linear velocity control mode is able to maintain an optimal linear velocity. Because the separation efficiency (HETP) of a column varies depending on the column oven temperature, this mode is ideal for temperature-programmed chromatography. The advanced flow controller (AFC) in the GC-2010 Plus system includes a constant linear velocity control mode as standard functionality. Provided the columns have the same phase ratio, it is possible in this mode to obtain GC-FID and GC-MS chromatograms with similar patterns by simply specifying the linear velocity setting.

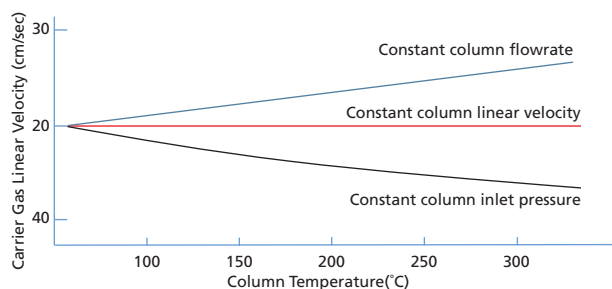
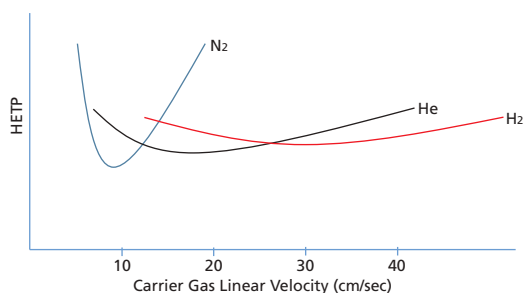

After using a GC-FID system to acquire data from a Class 2 standard solution A, data was acquired using a GC-MS system with the same linear velocity condition (35 cm/sec). A comparison of the resulting chromatograms shows that the difference in retention times between FID and MS data was 0.02 minutes for acetonitrile, which has a short retention time, and 1.2 seconds for cumene, which has a long retention time. The ability to easily obtain similar chromatogram patterns from FID and MS data acquired using columns with the same phase ratio under the same constant linear velocity conditions means that unknown peaks that appear in FID data can be qualitatively analyzed by comparing the FID data to the MS data.

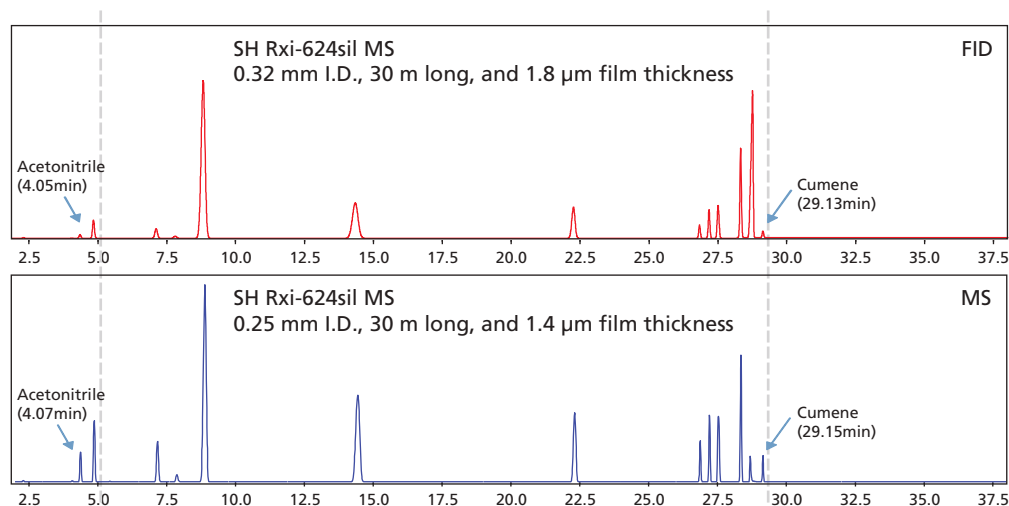

## Compliance with Data Integrity Requirements: GCMS-LabSolutions Analytical Data Management System

Many users, especially in the pharmaceutical industry, require compliance with regulations and guidelines, such as the CSV, PIC/S GMP, and Japanese Ministry of Health, Labour and Welfare ER/ES guidelines and FDA 21 CFR Part 11. They also are requiring more appropriate and efficient means of maintaining and managing instruments and analytical data. Therefore, starting with version 4.45, GCMSsolution is now compatible with LabSolutions DB/CS, so that LabSolutions can be used to manage analytical files and users for GC-MS systems.

- **Using LabSolutions for Integrated Management of Analytical Instruments, Including GC-MS Systems**

LabSolutions DB/CS systems can reduce data management costs by integrating the management of analytical files and user information for other analytical instruments as well.

- **Excellent Traceability Functionality**

The outstanding functionality for traceability supports maintaining audit trails for analytical files. Analytical files and operation histories are safely managed in a LabSolutions database, so that the necessary information can be easily accessed at any time.

- **Efficient Operation Under High-Security Conditions**

The system includes functionality for automatically locking the system after no operations have been performed for a given period, and for switching between different users during a series of consecutive analyses. These functions help ensure that the system can be operated efficiently under high-security conditions.

### Integrated Management of GC and GC-MS Systems from One PC

LabSolutions DB + GCMSsolution



- **GC-MS System with GC Detector**

The GCMS model, whether or not an HS unit or FID detector is connected, can be changed according to customer preferences. For more information about system configurations, contact your Shimadzu representative.

### Integrated (Networked) Management of Multiple Analytical Instruments

LabSolutions CS + GCMSsolution

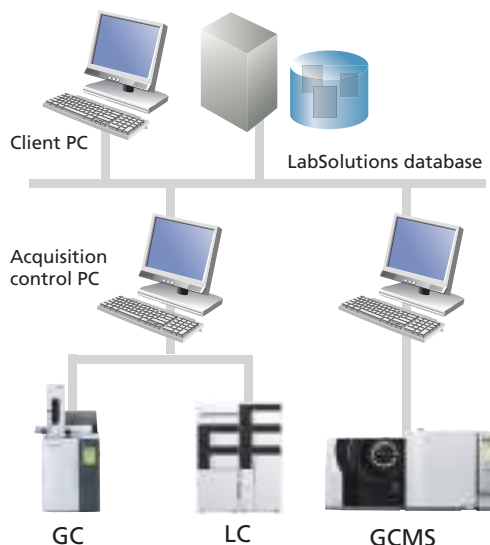

## System for Confirming Synthesized Compounds: DI-2010 Direct Sample Inlet Unit



Direct sample injection (DI) is a method of bypassing the gas chromatograph (GC) and injecting samples directly into the ion source. The technique is especially useful for applications such as measuring the mass spectra of synthesized compounds. It is also easy to use; simply attach a direct inlet unit to the GC-MS system configuration normally used. GC is not well suited to analyzing compounds that thermally decompose easily or that are difficult to vaporize, but using the DI method makes it easy to confirm the mass spectra of such compounds.

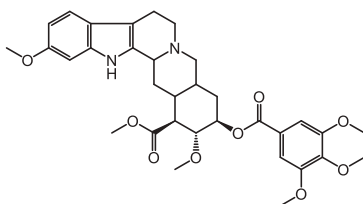

Example of Using DI-EI to Analyze Reserpine

## Qualitative Analysis of Unknown Compounds: Smart EI/CI Ion Source

Using a mass spectral library is an extremely convenient and reliable technique for identifying compounds. However, sometimes impurities and newly synthesized compounds are not registered in the library. Positive chemical ionization (CI) has conventionally been used to obtain molecular ion information for qualitative analysis of such compounds, but that requires exchanging ion sources when switching between EI and CI modes.

In contrast, the newly developed Smart EI/CI ion source can be used to acquire data using either EI or CI modes without exchanging ion sources.

- The high sensitivity of the revolutionary ion source results in no noticeable difference compared to using dedicated ion sources, either for EI or CI modes.
- Easily switchable between EI and CI modes without exchanging ion sources.
- In combination with a DI direct sample inlet unit, mass spectra can be acquired easily in either EI or CI mode.

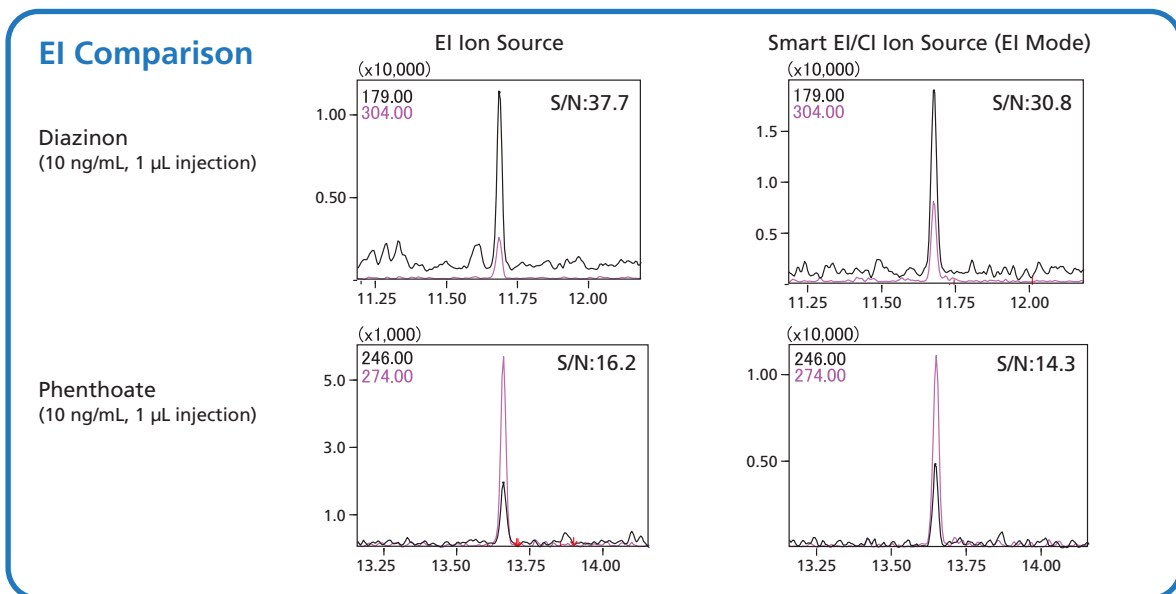

**Smart EI/CI Ion Source**  
Switchable without exchanging ion sources

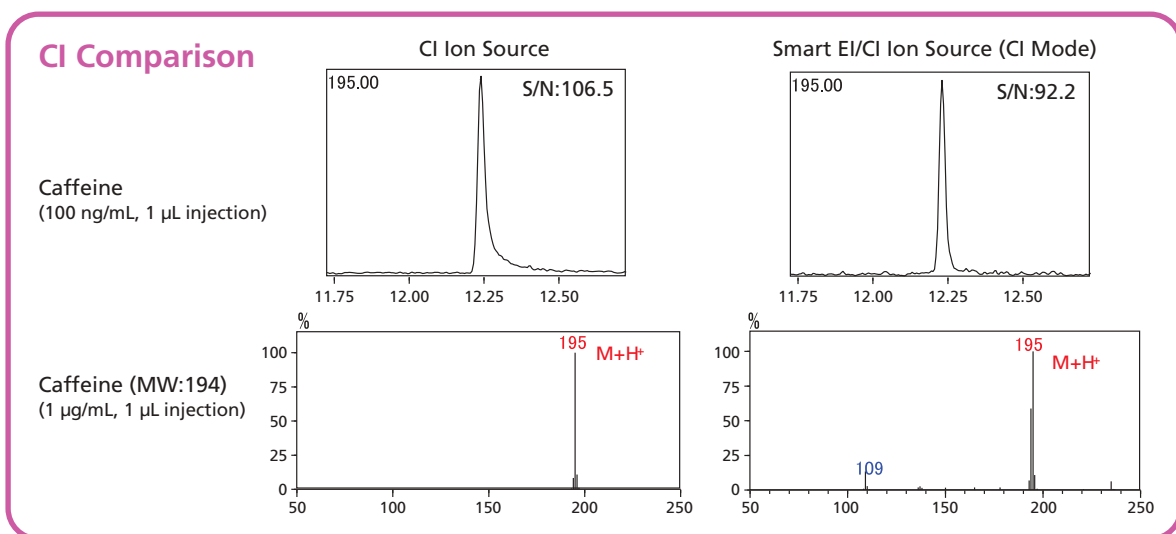

In the CI mode, using isobutane as the reagent gas is recommended, because it makes it easier to detect protonated molecules. The Smart EI/CI ion source is an optional product. It can be used with GCMS systems capable of chemical ionization.

## High-Sensitivity Analysis of Genotoxic Impurities: GCMS-TQ8050

Genotoxic (mutagenic) impurities must be controlled to low concentration levels. Therefore, high-sensitivity analytical instruments are required for their analysis. Triple quadrupole gas chromatograph mass spectrometers (GC-MS/MS) offer significantly higher selectivity by separating components by mass in two stages. Consequently, they are able to selectively detect trace quantities of genotoxic impurities with high sensitivity.

To maximize the benefits of OFF-AXIS ion optics, including both high ion transmission performance and outstanding noise elimination performance, the GCMS-TQ8050 now features a detector with higher amplification performance that achieves the world's highest sensitivity\*.

\* As of August 2016, according to a Shimadzu survey

The GCMS-TQ8050 supports measurements as a single-MS system (scan and SIM modes). It is also compatible with almost everything supported by the GCMS-QP2020, including those mentioned above (FID detector, software, DI unit, and Smart EI/CI ion source). Thus, users can configure systems according to their purposes.



Triple Quadrupole  
Gas Chromatograph Mass Spectrometer  
GCMS-TQ8050

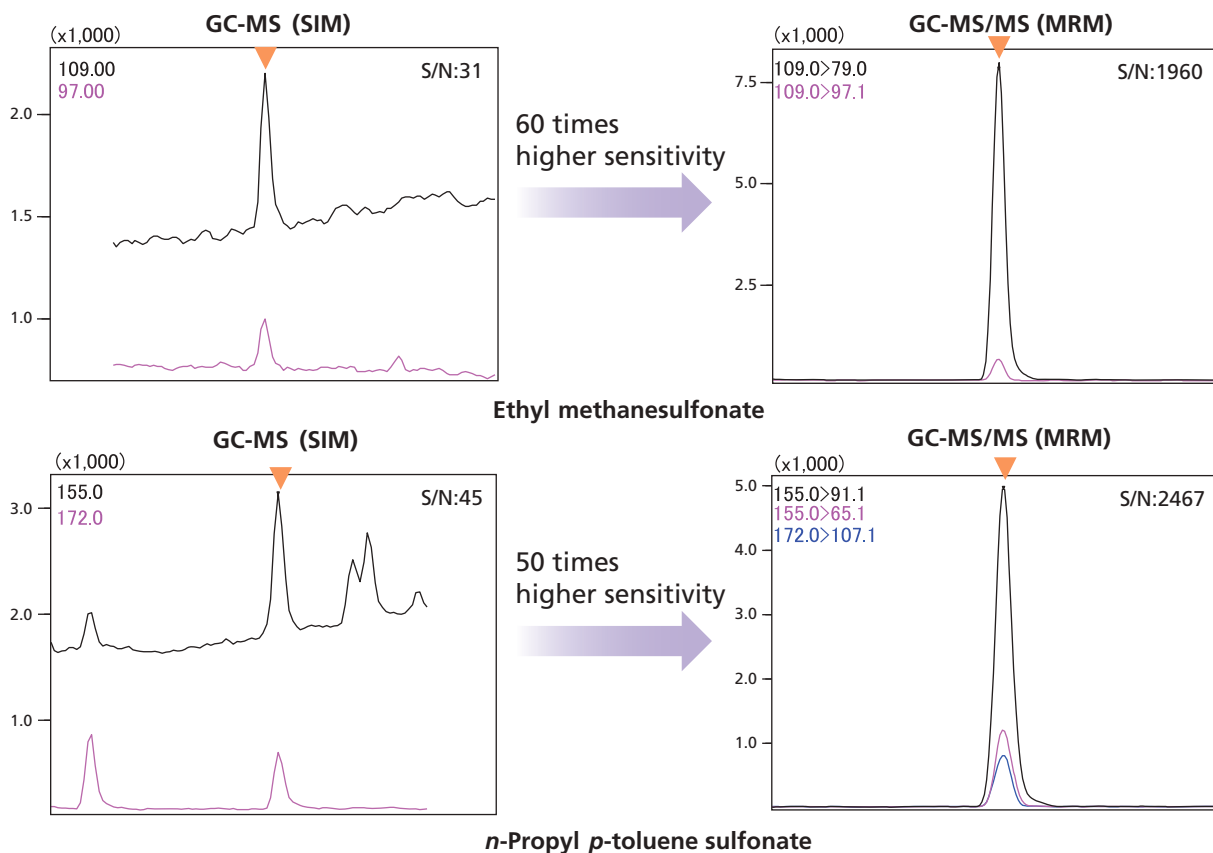

Solution concentration: 0.01 µg/mL [equivalent to a 1 ng/mg (1 ppm) concentration in pharmaceutical drug substances]



Shimadzu Corporation  
www.shimadzu.com/an/

**For Research Use Only. Not for use in diagnostic procedures.**

This publication may contain references to products that are not available in your country. Please contact us to check the availability of these products in your country. Company names, products/service names and logos used in this publication are trademarks and trade names of Shimadzu Corporation, its subsidiaries or its affiliates, whether or not they are used with trademark symbol "TM" or "®". Third-party trademarks and trade names may be used in this publication to refer to either the entities or their products/services, whether or not they are used with trademark symbol "TM" or "®". Shimadzu disclaims any proprietary interest in trademarks and trade names other than its own.

The contents of this publication are provided to you "as is" without warranty of any kind, and are subject to change without notice. Shimadzu does not assume any responsibility or liability for any damage, whether direct or indirect, relating to the use of this publication.

# Analysis of styrene leached from polystyrene cups using GCMS coupled with Headspace (HS) sampler

## ASMS 2014 TP763

Ankush Bhone<sup>(1)</sup>, Dheeraj Handique<sup>(1)</sup>, Prashant Hase<sup>(1)</sup>, Sanket Chiplunkar<sup>(1)</sup>, Durvesh Sawant<sup>(1)</sup>, Ajit Datar<sup>(1)</sup>, Jitendra Kelkar<sup>(1)</sup>, Pratap Rasam<sup>(1)</sup>, Nivedita Subhedar<sup>(2)</sup>

(1) Shimadzu Analytical (India) Pvt. Ltd., 1 A/B Rushabh Chambers, Makwana Road, Marol, Andheri (E), Mumbai-400059, Maharashtra, India.

(2) Ramnarain Ruia College, L. Nappo Road, Matunga (E), Mumbai-400019, Maharashtra, India.



# Analysis of styrene leached from polystyrene cups using GCMS coupled with Headspace (HS) sampler

## Introduction

Worldwide studies have revealed the negative impacts of household disposable polystyrene cups (Figure 1) on human health and environment.

Molecular structure of styrene is shown in Figure 2. Styrene is considered as a possible human carcinogen by the WHO and International Agency for Research on Cancer (IARC).<sup>[1]</sup> Migration of styrene from polystyrene cups containing beverages has been observed.<sup>[2]</sup> Styrene enters into our body through the food we take, mimics estrogens in the

body and can therefore disrupt normal hormonal functions. This could also lead to breast and prostate cancer.

The objective of this study is to develop a sensitive, selective, accurate and reliable method for styrene determination using low carryover headspace sampler, HS-20 coupled with Ultra Fast Scan Speed 20,000 u/sec, GCMS-QP2010 Ultra to assess the risk involved in using polystyrene cups.



Figure 1. Polystyrene cup

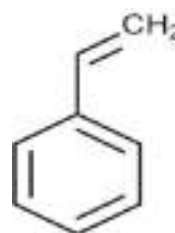

Figure 2. Structure of styrene

## Method of Analysis

### Extraction of styrene from polystyrene cups

This study was carried out by extracting styrene from commercially available polystyrene cups and recoveries were established by spiking polystyrene cups with standard solution of styrene. Solutions were prepared as follows,

- 1) Standard Stock Solution:  
1000 ppm of styrene standard stock solution in DMF: Water-50:50 (v/v) was prepared. It was further diluted with water to make 100 ppm and 1 ppm of standard styrene solutions.
- 2) Calibration Curve:  
Calibration curve was plotted using standard styrene solutions in the concentration range of 1 to 50 ppb with water as a diluent. 5 mL of each standard styrene solution was transferred in separate 20 mL headspace vials and crimped with automated crimper.
- 3) Sample Preparation:  
150 mL of boiling water (around 100 °C)<sup>[1]</sup> was poured into polystyrene cups. The cup was covered with aluminium foil and kept at room temperature for 1 hour. After an hour, 5 mL of sample from the cup was transferred into the 20 mL headspace vial and crimped with automated crimper.

Method was partly validated to support the findings by performing reproducibility, linearity, LOD, LOQ and recovery studies. For validation, solutions of different concentrations were prepared using standard stock solution of styrene (1000 ppm) as mentioned in Table 1.

## Analysis of styrene leached from polystyrene cups using GCMS coupled with Headspace (HS) sampler

Table 1. Method validation parameters

Parameter	Concentration (ppb)
Linearity	1, 2.5, 5, 10, 20, 50
Accuracy / Recovery	2.5, 10, 50
Precision at LOQ level	1
Reproducibility	50

### HS-GCMS Analytical Conditions

Figure 3 shows the analytical instrument, HS-20 coupled with GCMS-QP2010 Ultra on which samples were analyzed with following instrument parameter.



Figure 3. HS-20 coupled with GCMS-QP2010 Ultra by Shimadzu

### HS-GCMS analytical parameters

#### Headspace parameters

---

• Sampling Mode	: Loop
• Oven Temp.	: 80.0 °C
• Sample Line Temp.	: 130.0 °C
• Transfer Line Temp.	: 140.0 °C
• Equilibrating Time	: 20.00 min
• Pressurizing Time	: 0.50 min
• Pressure Equilib. Time	: 0.10 min
• Load Time	: 0.50 min
• Load Equilib. Time	: 0.10 min
• Injection Time	: 1.00 min
• Needle Flush Time	: 10.00 min
• GC Cycle Time	: 23.00 min

---

## Analysis of styrene leached from polystyrene cups using GCMS coupled with Headspace (HS) sampler

### Chromatographic parameters

• Column	: Rxi-5Sil MS (30 m L x 0.25 mm I.D., 0.25 µm)		
• Injection Mode	: Split		
• Split Ratio	: 10.0		
• Carrier Gas	: Helium		
• Flow Control Mode	: Linear Velocity		
• Linear Velocity	: 36.3 cm/sec		
• Pressure	: 53.5 kPa		
• Column Flow	: 1.00 mL/min		
• Total Flow	: 14.0 mL/min		
• Total Program Time	: 12.42 min		
• Column Oven Temp.	: Rate (°C /min)	Temperature (°C)	Hold time (min)
		50.0	0.00
	40.00	200.0	1.00
	30.00	280.0	5.00

### Mass Spectrometry parameters

• Ion Source Temp.	: 200 °C
• Interface Temp.	: 230 °C
• Ionization Mode	: EI
• Event Time	: 0.20 sec
• Mode	: SIM
• m/z	: 104,103 and 78
• Start Time	: 1.00 min
• End Time	: 5.00 min

## Results

### Fragmentation of styrene

Mass spectrum of styrene is shown in Figure 4. From the mass spectrum, base peak of m/z 104 was used for quantitation where as m/z 103 and 78 were used as reference ions.

SIM chromatogram of 50 ppb standard styrene solution

with m/z 104, 103 and 78 is shown in Figure 5.

Method validation data is summarized in Table 2. Figures 6 and 7 show overlay of SIM chromatograms for m/z 104 at linearity levels and calibration curve respectively.

## Analysis of styrene leached from polystyrene cups using GCMS coupled with Headspace (HS) sampler

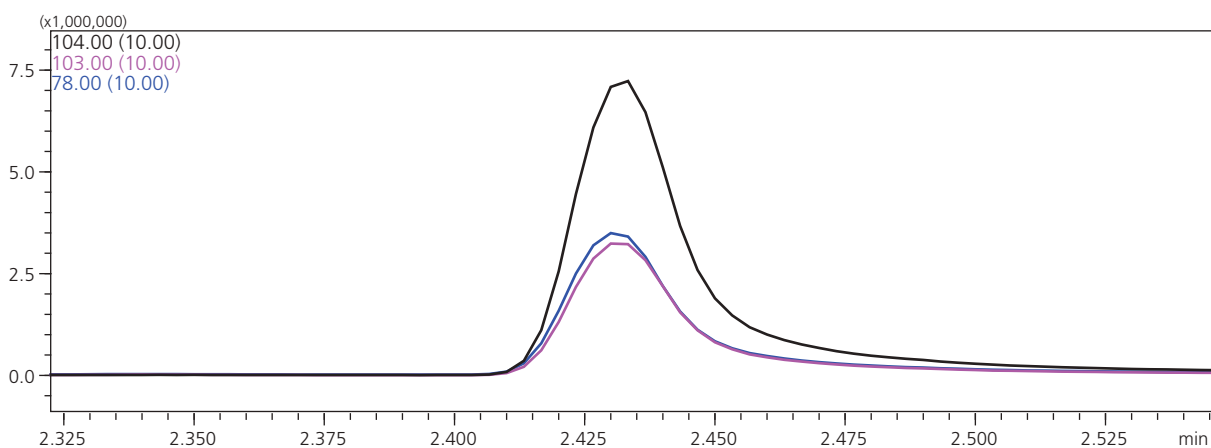
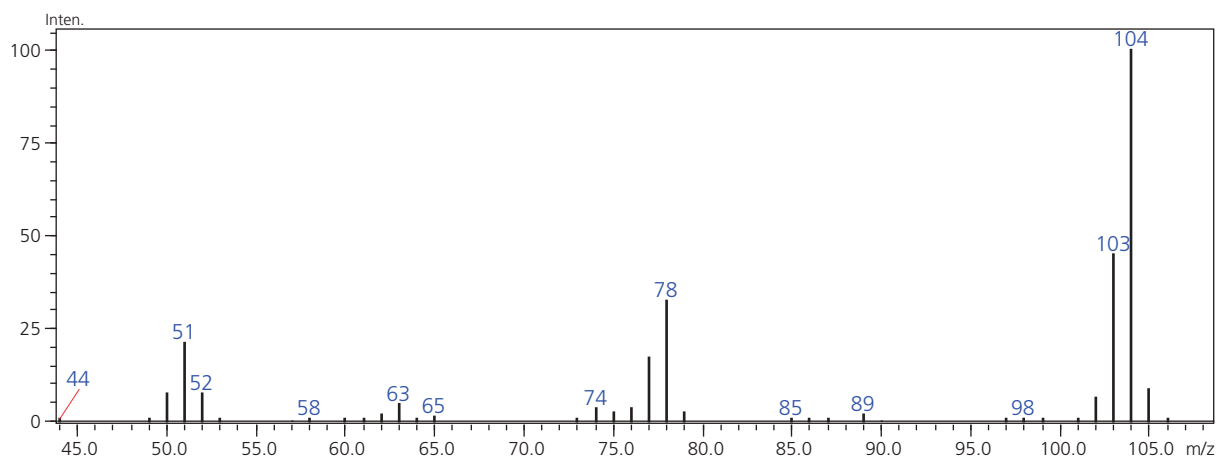

## Summary of validation results

Table 2. Validation summary

Sr. No.	Compound Name	Parameter	Concentration in ppb	Result
1	Styrene	Reproducibility (% RSD)	50	% RSD : 1.74 (n=6)
2		Linearity* (R <sup>2</sup> )	1 – 50	R <sup>2</sup> : 0.9996
3		LOD	1 – 50	LOD : 0.2 ppb
4		LOQ		LOQ : 1 ppb
5		Precision at LOQ	1	S/N ratio : 38 (n=6) % RSD : 3.2 (n=6)

\* Linearity levels – 1, 2.5, 5, 10, 20 and 50 ppb.

## Analysis of styrene leached from polystyrene cups using GCMS coupled with Headspace (HS) sampler

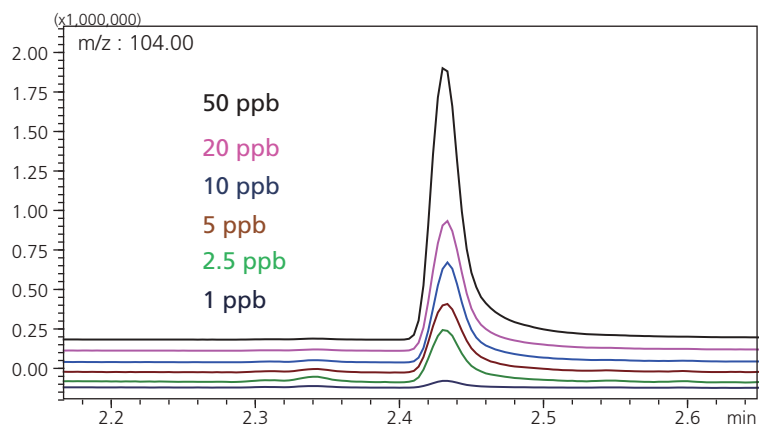

Figure 6. Overlay of SIM chromatograms for m/z 104 at linearity levels

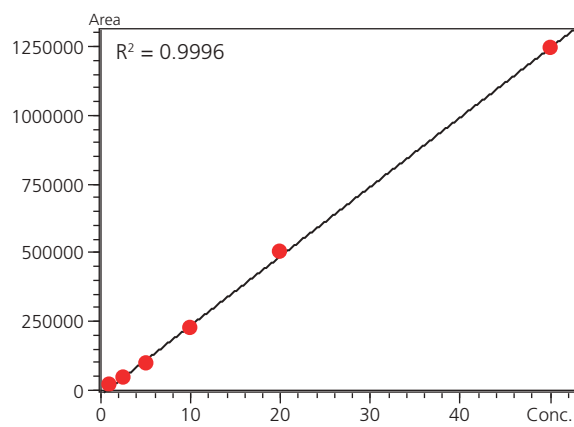

Figure 7. Calibration curve for Styrene

### Quantitation of styrene in polystyrene cup sample

Analysis of leachable styrene from polystyrene cups was done as per method described earlier. Recovery studies were carried out by spiking 2.5, 10 and 50 ppb of standard

styrene solutions in polystyrene cups. Figure 8 shows overlay SIM chromatogram of spiked and unspiked samples. Table 3 shows the summary of results.

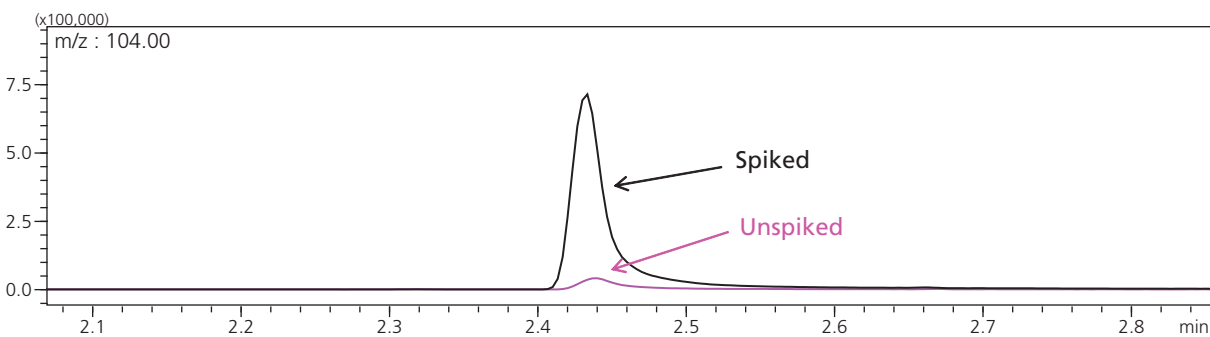

Figure 8. Overlay SIM chromatograms of spiked and unspiked samples

Table 3. Summary of results for sample analysis

Sr. No.	Sample Name	Parameter	Observed Concentration in ppb	Spiked Concentration in ppb	% Recovery
1	Unspiked sample	Precision	9.8	NA	NA
2	Spiked polystyrene cups	Recovery	12.0	2.5	88.0
			18.5	10	87.0
			55.9	50	92.2

## Analysis of styrene leached from polystyrene cups using GCMS coupled with Headspace (HS) sampler

### Conclusion

- HS-GCMS method was developed for quantitation of styrene leached from polystyrene cup. Part method validation was performed. Results obtained for reproducibility, linearity, LOQ and recovery studies were within acceptable criteria.
- With low carryover, the characteristic feature of HS-20 headspace, reproducibility even at very low concentration level could be achieved easily.
- Ultra Fast Scan Speed 20,000 u/sec is the characteristic feature of GCMS-QP2010 Ultra mass spectrometer, useful for quantitation of styrene at very low level (ppb level) with high sensitivity.

### References

- [1] Maqbool Ahmad, Ahmad S. Bajahlan, Journal of Environmental Sciences, Volume 19, (2007), 422, 424.
- [2] M. S. Tawfika; A. Huyghebaerta, Journal of Food Additives and Contaminants, Volume 15, (1998), 595.

# Application News

## No. J99A

### Inductively Coupled Plasma Atomic Emission Spectrometry

## Analysis by ICP Atomic Emission Spectrometry in Accordance with the ICH Q3D Guideline for Elemental Impurities Using ICPE-9820

#### ■ Introduction

Analysis of elemental impurities is one of the safety assessments required in the field of pharmaceuticals. In Japan, residual metal catalysts are classified as inorganic impurities according to the guidelines for Impurities in New Drug Substances (No. 1216001, issued by the Evaluation and Licensing Division, the Pharmaceutical and Food Safety Bureau, the Japanese Ministry of Health, Labour and Welfare), and are to be detected appropriately according to the method specified in the Japanese Pharmacopoeia, and evaluated at the stage of drug development. At the International Conference on Harmonisation of Technical Requirements for Registration of Pharmaceuticals for Human Use: ICH, various guidelines were established and harmonized between Japan, Europe, and the US, including guidelines for elemental impurities in pharmaceuticals, referred to as the ICH Q3D, Guideline for Elemental Impurities.

For the analysis of elemental impurities, the methods specified for use as general analytical methods in the First Supplement of the Sixteenth Edition of the Japanese Pharmacopoeia include inductively coupled plasma atomic emission spectrometry (ICP-AES), inductively coupled plasma mass spectrometry (ICP-MS), and atomic absorption spectrometry. Of these, ICP-AES is the most convenient, offering quick and easy multi-element analysis, and low running costs.

Here, we conducted analysis of 24 elements according to the ICH Q3D guidelines using the Shimadzu ICPE-9820 multi-type ICP atomic emission spectrometer. The ICPE-9820 offers simultaneous all element analysis with high sensitivity and high precision, while delivering high throughput. Low running costs are achieved by a unique combination of the reduced-flow mini-torch and vacuum optics, thereby reducing the overall consumption of argon.

#### ■ Outline of the ICH Q3D Guideline for Elemental Impurities

In the ICH Q3D Guideline for Elemental Impurities, 24 elemental impurities were identified as elements of concern due to their toxicity, and permitted daily exposure limits (PDE) were established. The elements include lead (Pb), cadmium (Cd), mercury (Hg), and arsenic (As), referred to as the "big four," as well as residual metal catalysts added intentionally in the synthesis of a drug substance. Table 1 shows the ICH Q3D Guideline (STEP4).

As permitted exposure values for the elemental impurities have been set as PDE values, the PDE values must be converted to concentrations to evaluate the elemental impurity components in the formulations or their component substances. As calculation methods, options 1, 2a, 2b, and 3 are available. Therefore, as long as the formulation is appropriate for the PDE value of the elemental impurity, any of the methods may be selected. Calculation examples for the respective options are shown in Table 2 to Table 5.

**Table 1 Permitted Daily Exposure for Elemental Impurities of ICH Q3D (STEP4)**

Class	Element	Oral µg/day	Parenteral µg/day	Inhalation µg/day	Class	Element	Oral µg/day	Parenteral µg/day	Inhalation µg/day
1	As	15	15	2	2B	Pt	100	10	1
	Cd	5	2	2		Se	150	80	130
	Hg	30	3	1		Rh	100	10	1
	Pb	5	5	5		Ru	100	10	1
2A	Co	50	5	3		Tl	8	8	8
	Ni	200	20	5		3	Ba	1400	700
	V	100	10	1	Cr		11000	1100	3
2B	Ag	150	10	7	Cu		3000	300	30
	Au	100	100	1	Li		550	250	25
	Ir	100	10	1	Mo		3000	1500	10
	Os	100	10	1	Sb		1200	90	20
	Pd	100	10	1	Sn		6000	600	60

**Table 2 Calculation by Option 1: Maximum Permitted Common Concentration Limits of Elemental Impurities Across Drug Product Components for Products with Daily Intake of Not More Than 10 Grams**

Component Substance	Max. Daily Intake of Each Substance (g)	PDE (µg)		Max. Permitted Concentration Assuming a 10 g Max. Daily Intake of Formulation (µg/g)		Max. Intake from Each Component (µg)	
				PDE/10 g		Max. Daily Intake (g) of Each Component × Max. Permitted Concentration (µg/g) of Each Component	
		Pb	As	Pb	As	Pb	As
Drug substance	0.2	5	15	0.5	1.5	0.1	0.3
MCC	1.1	5	15	0.5	1.5	0.55	1.65
Lactose	0.45	5	15	0.5	1.5	0.225	0.68
Calcium phosphate	0.35	5	15	0.5	1.5	0.175	0.53
Crospovidone	0.265	5	15	0.5	1.5	0.133	0.4
Magnesium stearate	0.035	5	15	0.5	1.5	0.018	0.05
HPMC	0.06	5	15	0.5	1.5	0.03	0.09
Titanium oxide	0.025	5	15	0.5	1.5	0.013	0.04
Iron oxide	0.015	5	15	0.5	1.5	0.008	0.02
Max. Daily Intake (Total)	2.5					1.25	3.75
PDE (µg/day)						5.0	15

**Table 3 Calculation by Option 2a: Maximum Permitted Common Concentration Limits Across Drug Product Component Materials for a Product with a Specified Daily Intake (Assuming That Concentration Remains Constant)**

Component Substance	Max. Daily Intake of Each Substance (g)	PDE (µg)		Max. Permitted Concentration (µg/g)		Max. Intake from Each Component (µg)	
				PDE/Max. Daily Intake of Actual Drug (e.g. 2.5 g)		Max. Daily Intake (g) of Each Component × Max. Permitted Concentration (µg/g) of Each Component	
		Pb	As	Pb	As	Pb	As
Drug substance	0.2	5	15	2	6	0.4	1.2
MCC	1.1	5	15	2	6	2.20	6.6
Lactose	0.45	5	15	2	6	0.9	2.7
Calcium phosphate	0.35	5	15	2	6	0.7	2.1
Crospovidone	0.265	5	15	2	6	0.53	1.59
Magnesium stearate	0.035	5	15	2	6	0.07	0.21
HPMC	0.06	5	15	2	6	0.12	0.36
Titanium oxide	0.025	5	15	2	6	0.05	0.15
Iron oxide	0.015	5	15	2	6	0.03	0.09
Max. Daily Intake (Total)	2.5					5.0	15
PDE (µg/day)						5.0	15

**Table 4 Calculation by Option 2b: Maximum Permitted Common Concentration Limits Across Drug Product Component Materials for a Product with a Specified Daily Intake (Arbitrary Setting of Maximum Concentration Possible from Actual Value)**

Component Substance	Max. Daily Intake of Each Substance (g)	PDE (µg)				Measured Concentration Value (µg)				Arbitrary Setting of Max. Concentration Possible from Actual Value (µg/g)				Max. Daily Intake of Each Component (µg)			
		Pb	As	Pd	Ni	Pb	As	Pd	Ni	Pb	As	Pd	Ni	Pb	As	Pd	Ni
Drug substance	0.2	5	15	100	200	**	0.5	20	50	**	5	500	200	**	1	100	40
MCC	1.1	5	15	100	200	0.1	0.1	*	**	0.5	5	*	**	0.55	5.5	*	**
Lactose	0.45	5	15	100	200	0.1	0.1	*	**	0.5	5	*	**	0.225	2.3	*	**
Calcium phosphate	0.35	5	15	100	200	1	1	*	5	5	5	*	200	1.75	1.8	*	70
Crospovidone	0.265	5	15	100	200	0.1	0.1	*	**	0.5	5	*	**	0.132	1.3	*	**
Magnesium stearate	0.035	5	15	100	200	0.5	0.5	*	0.5	5	10	*	50	0.175	0.4	*	1.75
HPMC	0.06	5	15	100	200	0.1	0.1	*	**	2.5	5	*	**	0.15	0.3	*	**
Titanium oxide	0.025	5	15	100	200	20	1	*	**	40	20	*	**	1	0.5	*	**
Iron oxide	0.015	5	15	100	200	10	10	*	50	20	100	*	200	0.3	1.5	*	3
Max. Daily Intake (Total)	2.5													4.3	14.5	100	115
PDE (µg/day)														5	15	100	200

\*: Since it has been determined that there is no possibility of Pd being present, a quantitative result is not obtained.

\*\* : Below the detection limit



**Table 5 Calculation by Option 3: Finished Product**  
Concentration (µg/g) = PDE (µg/day)/Daily intake of drug product (g/day)

	Daily Intake (g)	PDE (µg)				Maximum Permitted Concentration (µg/g)			
		Pb	As	Pd	Ni	Pb	As	Pd	Ni
Drug Product	2.5	5	15	100	200	2	6	40	80

### ■ Sample

- Ophthalmic solution
- Tablet (Daily intake: 1 tablet (0.2 g))

### ■ Sample Preparation

#### 1. Pretreatment of sample (ophthalmic solution)

To 2 mL of sample (approximately 2 g), add 0.5 mL hydrochloric acid, 0.5 mL nitric acid and internal standard element Y (0.5 mg/L based on measurement solution concentration). Adjust the volume to 10 mL using distilled water to use as the measurement solution (5-fold dilution). A spike-and-recovery test solution was prepared using a similarly prepared solution spiked with a standard solution of the measurement element.

#### 2. Pretreatment of tablet sample

Two tablets (daily dosage of 1 tablet per day (0.20 g)) were dissolved with 3 mL hydrochloric acid and 2 mL nitric acid using a microwave sample preparation system and a sample pretreatment quartz vessel.

After conducting microwave digestion, the solution volume was adjusted to 20 mL with distilled water to use as the measurement solution (50-fold dilution). At this time, the internal standard elements Y and In (Y at 0.5 mg/L and In at 1.0 mg/L) were added to the solution. Also, prior to digestion, the measurement element was added to prepare a spike-and-recovery test solution.

### ■ Instrument and Analytical Conditions

Measurement was conducted using the Shimadzu ICPE-9820 multi-type ICP atomic emission spectrometer. The measurement conditions are shown in Table 6.

The ICPE-9820 is a spectrometer that uses the latest CCD, permitting simultaneous measurement of all elements and all wavelengths, while its high-sensitivity axial observation permits high-throughput measurement. Further, the high-temperature plasma generated by the mini torch assures high sensitivity with low ionization interference to provide acquisition of accurate values. In addition, the mini-torch plasma produced by low-flowrate argon gas, the Eco mode and the vacuum spectrometer greatly reduce running costs.

**Table 6 Analytical Conditions**

Instrument	: ICPE-9820
Radio frequency power	: 1.2 kW
Plasma gas Flowrate	: 10 L/min
Auxiliary gas Flowrate	: 0.6 L/min
Carrier gas Flowrate	: 0.7 L/min
Sample introduction	: Nebulizer 10
Misting chamber	: Cyclone chamber
Plasma torch	: Mini-Torch
Observation	: Axial (AX) / Radial (RD)

### ■ Analysis

Quantitative analysis of the 24 elements subject to the ICH Q3D guidelines was conducted using the calibration curve-internal standard method, and spike-and-recovery testing was also conducted.

### ■ Analytical Results

Table 7 shows the results of analysis of the ophthalmic solution. The PDE value of the ophthalmic solution was used as the parenteral value. Table 8 shows the results of the tablet analysis. Good results were obtained in the spike-and-recovery testing for each of the samples (Tables 7 and 8<sup>1)</sup>). In addition, the detection limit calculated as the concentration in the sample (Tables 7 and 8<sup>2)</sup>) adequately satisfied the permitted concentrations (Tables 7 and 8<sup>3)</sup>).

### ■ Conclusion

Use of the ICPE-9820 permits quick, accurate analysis of the 24 elements specified in the ICH Q3D guideline.

#### [References]

- 1) Impurities in New Drug Substances (No. 1216001, issued by the Evaluation and Licensing Division, the Pharmaceutical and Food Safety Bureau, the Japanese Ministry of Health, Labour and Welfare)
- 2) First Supplement of the Sixteenth Edition of the Japanese Pharmacopoeia
- 3) ICH Q3D: Guideline for Elemental Impurities (STEP4)

Table 7 Analytical Results of Eye Drop

Element	PDE value for parenteral	*3 Permitted concentration	Post-treatment concentration	Spike concentration	Measured concentration (Eye drop)	*1 Spike-and-recovery rate	*2 Converted detection limit (3σ) in ophthalmic solution
	μg	μg/mL	μg/mL	μg/mL	μg/mL	%	μg/mL
As	15	15	3	1	<DL	104	0.04
Cd	2	2	0.4	0.4	<DL	101	0.0006
Hg	3	3	0.6	0.3	<DL	105	0.007
Pb	5	5	1	0.3	<DL	102	0.01
Co	5	5	1	0.3	<DL	95	0.001
Ni	20	20	4	0.5	<DL	104	0.003
V	10	10	2	0.5	<DL	98	0.0008
Ag	10	10	2	0.5	<DL	104	0.0008
Au	100	100	20	0.5	<DL	99	0.006
Ir	10	10	2	0.5	<DL	101	0.01
Os	10	10	2	0.5	<DL	103	0.006
Pd	10	10	2	0.5	<DL	102	0.004
Pt	10	10	2	0.5	<DL	99	0.02
Se	80	80	16	0.5	<DL	103	0.02
Rh	10	10	2	0.5	<DL	95	0.007
Ru	10	10	2	0.5	<DL	103	0.003
Tl	8	8	1.6	0.5	<DL	95	0.02
Ba	700	700	140	0.5	<DL	96	0.0006
Cr	1100	1100	220	0.5	<DL	97	0.002
Cu	300	300	60	0.5	<DL	96	0.002
Li	250	250	50	0.5	<DL	99	0.01
Mo	1500	1500	300	0.5	<DL	100	0.003
Sb	90	90	18	0.5	<DL	103	0.01
Sn	600	600	120	0.5	<DL	100	0.01

PDE value for parenteral

Permitted concentration : When 1 mL of the ophthalmic solution is used per day (Option 3 is used when calculating the conversion to the PDE concentration)

Post-treatment concentration : The permitted concentration in the measurement sample after pretreatment of the sample

Spike concentration : Concentration of spiking solution in spike-and-recovery testing

Converted detection limit (3σ) in ophthalmic solution: Detection limit (3σ) in measurement solution × Dilution factor (5)

<DL: Below the detection limit (3σ)

Table 8 Analytical Results of Tablet

Element	PDE value for oral	*3 Permitted concentration	Post-treatment concentration	Spike concentration	Measured concentration (Tablet)	*1 Spike-and-recovery rate	*2 Tablet converted detection limit (3σ)
	μg	μg/g	μg/mL	μg/mL	μg/g	%	μg/g
As	15	75	1.5	0.5	<DL	107	0.5
Cd	5	25	0.5	0.1	<DL	100	0.007
Hg	30	150	3	1	<DL	101	0.1
Pb	5	25	0.5	0.1	<DL	98	0.07
Co	50	250	5	1	<DL	101	0.01
Ni	200	1000	20	1	0.1	100	0.03
V	100	500	10	1	<DL	103	0.01
Ag	150	750	15	1	<DL	104	0.02
Au	100	500	10	1	<DL	105	0.03
Ir	100	500	10	1	<DL	100	0.09
Os	100	500	10	1	<DL	85	0.04
Pd	100	500	10	1	<DL	106	0.05
Pt	100	500	10	1	<DL	102	0.3
Se	150	750	15	1	<DL	108	0.3
Rh	100	500	10	1	<DL	101	0.1
Ru	100	500	10	1	<DL	100	0.03
Tl	8	40	0.8	0.1	<DL	103	0.2
Ba	1400	7000	140	1	<DL	102	0.003
Cr	11000	55000	1100	1	<DL	101	0.02
Cu	3000	15000	300	1	<DL	105	0.05
Li	550	2750	55	1	<DL	104	0.1
Mo	3000	15000	300	1	<DL	101	0.03
Sb	1200	6000	120	1	<DL	105	0.1
Sn	6000	30000	600	1	<DL	100	0.03

PDE value for oral

Permitted concentration : Permitted concentration in daily intake (0.2 g) (Option 3 is used for calculation of conversion from PDE to concentration)

Post-treatment concentration : Permitted limit concentration in measurement solution following sample pretreatment

Spike concentration : Concentration of the added spike-and-recovery test solution

Tablet converted detection limit (3σ): Detection limit (3σ) in measurement solution Dilution factor (50)

<DL: Below the detection limit (3σ)

Find us on 



Linked 



First Edition: March, 2018



**For Research Use Only. Not for use in diagnostic procedures.**

This publication may contain references to products that are not available in your country. Please contact us to check the availability of these products in your country.

The content of this publication shall not be reproduced, altered or sold for any commercial purpose without the written approval of Shimadzu. Company names, products/service names and logos used in this publication are trademarks and trade names of Shimadzu Corporation, its subsidiaries or its affiliates, whether or not they are used with trademark symbol "TM" or "®".

Third-party trademarks and trade names may be used in this publication to refer to either the entities or their products/services, whether or not they are used with trademark symbol "TM" or "®".

Shimadzu disclaims any proprietary interest in trademarks and trade names other than its own.

The information contained herein is provided to you "as is" without warranty of any kind including without limitation warranties as to its accuracy or completeness. Shimadzu does not assume any responsibility or liability for any damage, whether direct or indirect, relating to the use of this publication. This publication is based upon the information available to Shimadzu on or before the date of publication, and subject to change without notice.

Shimadzu Corporation  
[www.shimadzu.com/an/](http://www.shimadzu.com/an/)